



**ACOUSTIC
INSPIRATION**

IMPRESSUM

CONCEPT

Amadeus Schneider | schneiderbrett.com
Daniel Rohrer | CIRKEL.ch

PHOTOGRAPHY

Michal Florence Schorro
Nicolas Duc
Sandro Mazzola (Cover Shot)
Severin Ettlin
Terence Du Fresne
Yosuke Kojima

LAYOUT & GRAPHICS

Amadeus Schneider | schneiderbrett.com

TEXT

Daniel Rohrer | CIRKEL.ch

PRINT

Fromm Druck GmbH | druckhaus-fromm.de

COMPANY

ECHOJAZZ AG
Ringstrasse 25
CH-6010 Kriens
Schweiz
www.echojazz.com
info@echojazz.com
+41 41 340 18 80
Commercial register no.: CHE-382.449.661
Commercial Register Office: Luzern

VERSION

EN-20230512

VALID UNTIL

30.06.2023

DIGITAL VERSION

www.echojazz.com/download/brochure



TABLE OF CONTENTS

COMPANY PROFILE		
ACOUSTIC INSPIRATION	6	COMPANY PROFILE
SUSTAINABILITY BY DESIGN	8	
ACOUSTICS AND ENVIRONMENT	10	
HIGH PERFORMANCE	12	
ACOUSTIC MATERIAL		MATERIAL
ECHOBOARD®	16	
DATA SHEET ECHOBOARD® 12MM	20	
COLOURS ECHOBOARD® 12MM	21	
DATA SHEET ECHOBOARD® 24MM	24	
COLOURS ECHOBOARD® 24MM	25	
ECHOCOUSTIC®	26	
DATA SHEET ECHOCOUSTIC® 25MM	30	
COLOURS ECHOCOUSTIC® 25MM	31	CEILING
ECHOFLAKES®	32	
ACOUSTIC PRODUCTS		
ACOUSTIC-CEILING	37	
ECHOORBIT®	38	
ECHOSAIL®	42	
ECHOBAFFLE®	46	
ECHOGRID®	50	LIGHTING
ACOUSTIC-LIGHTING	55	
ECHOLED® EQ4	56	
ECHOLED® CONE	60	
ECHOLED® UMBRA	64	
ECHOLED® LINEAR	68	
ECHOLED® BAFFLE	72	
ACOUSTIC-WALLS	77	WALLS
ECHOBAFFLE® WALL	78	
ECHOFIELD®	82	
ECHOBRICK®	86	
ECHOMONOC®	92	
ECHOCOUSTIC® ACCENT	96	
ACOUSTIC-PARTITIONS	101	PARTITIONS
ECHOCURTAIN®	102	
ECHOTORRENT®	106	
ECHOCOVE® ECO	110	
ECHOCOVE® PALING	116	
ECHOCOVE® STAND	120	
ECHOCOVE® MOVE	124	
ECHOCOVE® DESK	128	
ACOUSTIC-FURNITURE	135	FURNITURE
EHOCRATE®	136	
ECHONOTE®	140	
ECHOTOWER® SQUARE	144	
ECHOTOWER® ROUND	148	
MCART	152	
ECHOCARRY	156	
ECHOBOX®	160	
ADDITIONAL ITEMS	165	ADDITIONAL ITEMS
ECHOCOUSTIC® 25MM PROFILE	167	
ECHOBAFFLE® CUSTOM DESIGN OPTIONS	169	
ECHOLED® EQ4 PIN BY BARTENBACH	171	
ECHOLED® LINEAR LED	171	
ECHOCOVE® JOINER	173	
ECHOCOVE® DESK ADAPTER	175	
MCART ELECTRICAL SOCKET	177	
EHOCRATE® SUSPENSION PROFILE	179	
ECHONOTE® 12MM COVER	181	
CREATE		CREATE
COLOURS	185	
PERFORATIONS	189	

Customised high-performance sound absorbers for a noticeable improvement in well-being and room quality. ECHO**JAZZ** EchoBoards® are made from recycled PET bottles. 100% Swiss design, 100% zero waste.

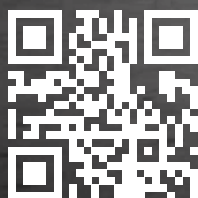
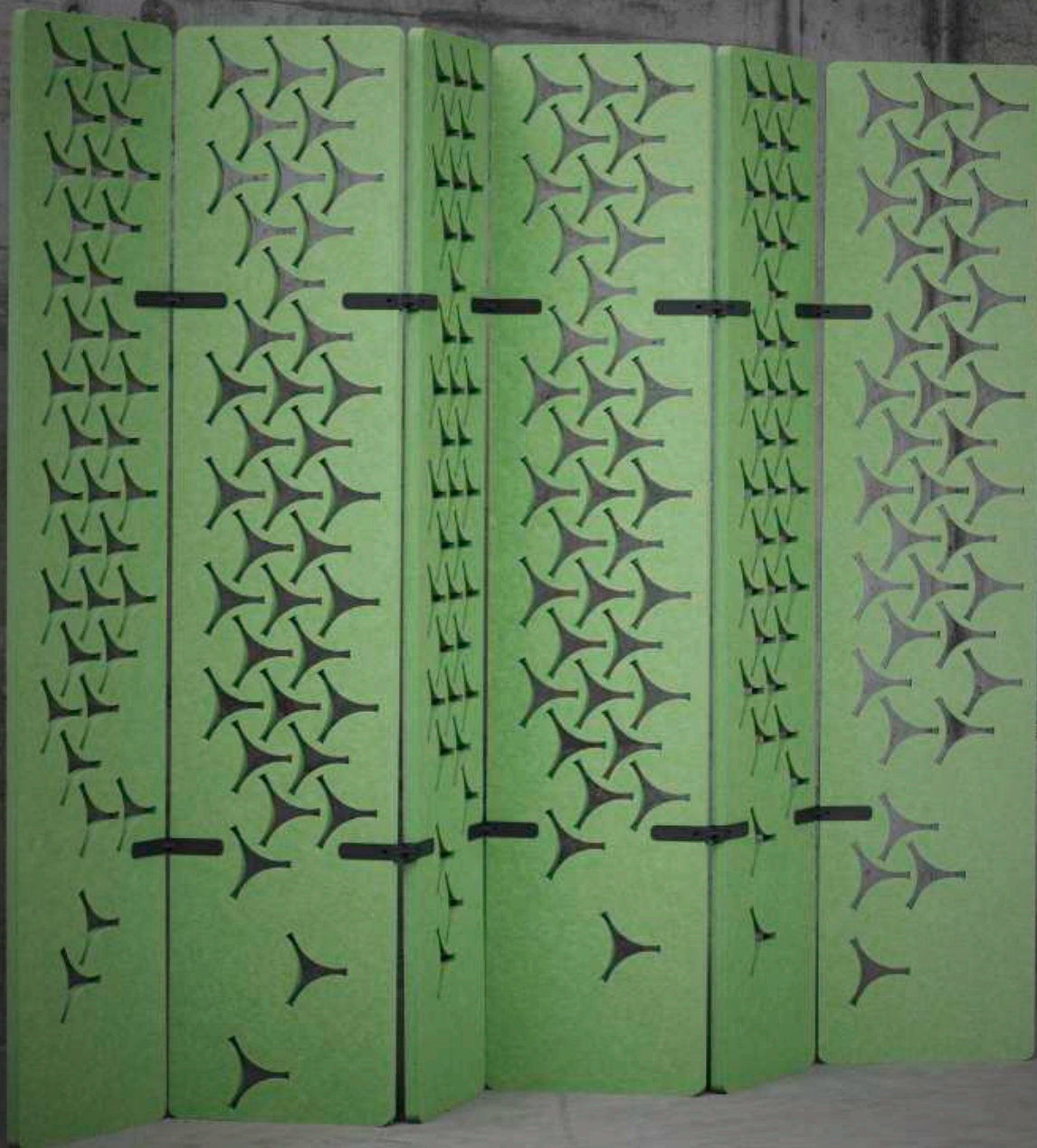



COMPANY PROFILE

MATERIAL

CEILING

LIGHTING

WALLS

PARTITIONS

FURNITURE

ADDITIONAL ITEMS

CREATE



COMPANY PROFILE

ACOUSTIC INSPIRATION

Ecological, robust and flexible high-performance sound absorbers made from recycled PET bottles, tailor-made for individual solutions to increase comfort and room quality in architecture, gastronomy, creative industries, open office spaces, school buildings, swimming pools, hotelery and your home. 100% Swiss design, 100% zero waste.

Made from 74 PET bottles per square metre, we process our **ECHOJAZZ** EchoBoards® into functional design elements. The soft, felt-like feel matches a wide range of natural materials such as stone, concrete, wood, metal and glass. **ECHOJAZZ** products are fire protection certified and available in up to 34 colours. Staged as a real eye-catcher or cleverly concealed - **ECHOJAZZ** improves the feeling of space in a noticeably pleasant way and with a lasting effect.



ECHOCURTAIN®



ECHOCOVE® DESK



ECHOTOWER®



SUSTAINABILITY BY DESIGN

To noticeably improve well-being and room quality, we create high-performance sound absorbers for architecture, gastronomy, creative industries, open office spaces and your home. Our ready-made products are designed for you in Kriens and have the highest standards of design and simplicity.

More ecological, more robust and more flexible in use than any other comparable product: all our products are based on the use of durable high-tech felt made from 100% PET. It was our upmost goal to ensure that the ECHOJAZZ products contain the highest possible proportion of recycled PET material and that the result is deceptively close to the beauty and properties of traditional wool.

Our product is for your project: We take care of individual and tailor-made solutions that address a wide range of projects and offer a large range of smart standard products.

And after the project is before the project: Through our stewardship programme, we can recycle 100% of used ECHOJAZZ products.

COMPANY PROFILE

MATERIAL

CEILING

LIGHTING

WALLS

PARTITIONS

FURNITURE

ADDITIONAL ITEMS

CREATE



ACOUSTICS AND ENVIRONMENT

At ECHOJAZZ, we combine sustainability with the simplicity of design of highest and most vanguard standards. In order not to burden our nature, only the cycle comes into question for us: recycled raw materials, recyclable products, zero waste.

From disposable plastic to high-quality end products for the design industry: for our products we use 100% PET with a minimum of 50% recycled PET. Compared to the production of virgin PET, the use of recycled PET saves up to 84% of the energy. Individual products are complemented with recycled and recyclable steel

Closed loop: ECHOJAZZ is the only manufacturer to offer a take-back programme for all products. This means that all products can be returned for recycling at the end of their life cycle.

100% Zero Waste: We generate raw material for new products from used products and the residual material created during production.

On to the emission-free future: ECHOJAZZ products are already processed locally in Kriens, and we aim to have as many raw materials as possible manufactured as close to our site as possible.





ECHOTOWER®

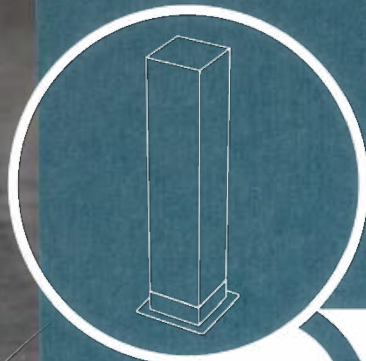

FILLING MATERIAL



ECHOFLAKES®

ZERO WASTE

WASTE STEWARDSHIP PROGRAMME

SHREDDING

OLD ECHOJAZZ PRODUCTS
PRODUCTION OFFCUTS

CLING



BOARD®

HIGH PERFORMANCE

The world is changing at breakneck speed: space and tranquillity are becoming rare commodities. Whether in a creative open office, in a simple waiting room or in trendy restaurant concepts - people should feel comfortable in all rooms. We offer solutions that improve heavily frequented and acoustically stressed rooms: noticeably, audibly, sustainably.

Design without compromise: The time of carpet wallpaper and thick curtains in dim conference rooms is over. We will contain acoustic disturbance elements in every room without restricting modern design visions and architecture.

Sustainability without compromise: The construction industry is one of the biggest waste generators on our planet. This must change. We start with a product that is 100% recyclable. We achieve the UN Sustainable Development Goals (SDGs) for responsible consumption and production.

Unlimited inspiration: It is in the hands of the creative industries to reinvent flawed materials, products and business models, to model sustainability and inspire people. Let's get started!



SOUND-ABSORBING

The open and compressed felt structure is 40% thinner than comparable high-performance absorbers.



ROBUST

Very dimensionally stable, tear-resistant and cleanable without residues.



REGULATING

Pleasant indoor climate thanks to balancing temperature and humidity.



EASY TO PROCESS

Individually cut on the CNC cutting plotter, easily customisable on site.



FIRE SAFETY

European fire protection classification: B-s1/s2, d0, hardly any smoke development and no burning dripping.



MOLD-FREE

Because the fibre does not absorb water, the EchoBoard® dries very well.



EMISSION-FREE

Does not emit hazardous fibres or paint particles.



LIGHTFASTNESS

The fibres are dyed in the liquid state and do not fade.

The robust and easy-care basic elements EchoBoard® and EchoCoustic® can be used for a large number of individual design ideas and allow creative wishes regarding shapes, colours, perforation and areas of application.





COMPANY PROFILE

MATERIAL

CEILING

LIGHTING

WALLS

PARTITIONS

FURNITURE

ADDITIONAL ITEMS

CREATE

ACOUSTIC MATERIAL

ECHOBARD®

EchoBoard® is the basic material for optimal room acoustics. All ECHO**JAZZ** acoustic ceilings, acoustic luminaires, acoustic walls and acoustic room dividers are produced from this absorber. It can be processed in many ways to meet ever new creations and customer requirements. The ECHO**JAZZ** development team is happy to help develop customised solutions according to design proposals or DWG cutting plans. There is a choice of the classic 24mm or thinner 12mm. ECHO**JAZZ** offers its own mounting kits for easy installation.



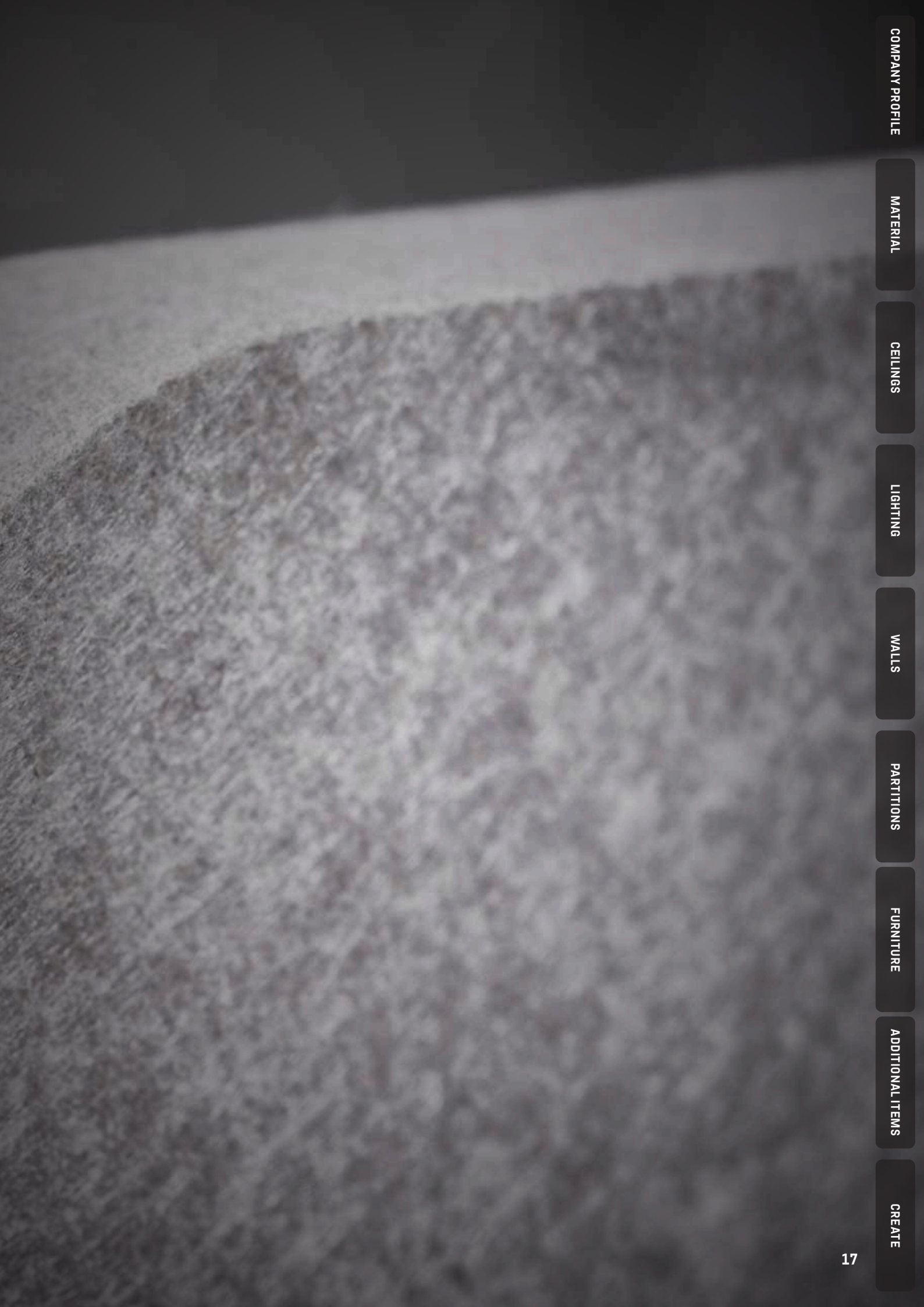

COMPANY PROFILE

MATERIAL

CEILING

LIGHTING

WALLS

PARTITIONS

FURNITURE

ADDITIONAL ITEMS

CREATE



ECHOBOARD® 12MM

EchoBoard® 12mm is a high-quality sound absorber with an α_w of up to 0.90 and a NRC of up to 0.85, which can be used for ceilings, walls, on tables or freely in space.

Absorption coefficient: α_w 0.90, class A

NAME	COLOUR	ARTICLE	W x H x D (in mm)	UNIT	PET-BOTTLES
EchoBoard® 12mm	105	PET12REC105001A	1200x2800x12	1 Pce	168
EchoBoard® 12mm	111	PET12REC111001A	1200x2800x12	1 Pce	168
EchoBoard® 12mm	155*	PET12REC155000A	1180x2380x12	1 Pce	140
EchoBoard® 12mm	204	PET12REC204001A	1200x2800x12	1 Pce	168
EchoBoard® 12mm	244	PET12REC244001A	1200x2800x12	1 Pce	168
EchoBoard® 12mm	245	PET12REC245001A	1200x2800x12	1 Pce	168
EchoBoard® 12mm	809	PET12REC809001A	1200x2800x12	1 Pce	168

*This colour is only available in size 1180x2380x12mm.

ECHOBOARD® 12MM

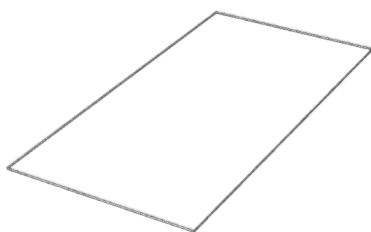

DATA SHEET ECHOBOARD® 12MM

EchoBoard® 12mm is a high quality sound absorber with an aw of up to 0.90 and a NRC of up to 0.85, which can be used for acoustic ceilings, walls, office desks or room dividers.

NAME	EchoBoard® 12mm																												
DIMENSIONS	1200mm (± 1mm) x 2800mm (± 1mm)																												
COMPOSITION	100% PET (> 50% recycled PET)																												
PET-BOTTLES* PER PANEL	168 PET-Bottles *The number of PET bottles refers to 500ml PET bottles with a bottle weight of 24g.																												
WEIGHT	2400g/m ² (± 10%)																												
MATERIAL THICKNESS	12mm																												
LIGHT FASTNESS ISO 105-B02-1994	> 7																												
FIRE PROTECTION EN 13501	B-s1, d0																												
VOC EMISSIONS ASTM D5116	< 0.5mg/m ² /h																												
FORMALDEHYDE EMISSIONS ASTM D5116	< 0.1mg/m ² /h																												
ENVIRONMENTAL CERTIFICATES	eco1 Minergie-Eco Cradle to Cradle Certified® Bronze M1 emission-free materials																												
ABSORPTION COEFFICIENT DIN EN ISO 11654 ASTM C423	aw 0.30 (direct mounting) aw 0.60 (50mm wall/ceiling distance) aw 0.90 (200mm wall/ceiling distance) NRC = 0.45 (direct mounting) NRC = 0.70 (50mm wall/ceiling distance) NRC = 0.85 (200mm wall/ceiling distance)																												
COLOURS	7																												
ABSORPTION GRAPH	<p>The graph plots the Sound Absorption Coefficient (Y-axis, 0.00 to 1.20) against Frequency in Hertz (X-axis, 125 to 4000 Hz). Three data series are shown: direct mounting (green line), 50mm wall/ceiling distance (yellow line), and 200mm wall/ceiling distance (blue line). All series show an overall increasing trend with frequency, with the 200mm distance configuration consistently providing the highest absorption across the measured range.</p> <table border="1"> <caption>Approximate data points from the Absorption Graph</caption> <thead> <tr> <th>Frequency (Hz)</th> <th>Direct Mount (aw)</th> <th>50mm Distance (aw)</th> <th>200mm Distance (aw)</th> </tr> </thead> <tbody> <tr> <td>125</td> <td>0.02</td> <td>0.10</td> <td>0.52</td> </tr> <tr> <td>250</td> <td>0.08</td> <td>0.25</td> <td>0.80</td> </tr> <tr> <td>500</td> <td>0.20</td> <td>0.60</td> <td>0.92</td> </tr> <tr> <td>1000</td> <td>0.50</td> <td>0.90</td> <td>0.80</td> </tr> <tr> <td>2000</td> <td>0.80</td> <td>0.95</td> <td>0.90</td> </tr> <tr> <td>4000</td> <td>0.95</td> <td>0.90</td> <td>0.95</td> </tr> </tbody> </table>	Frequency (Hz)	Direct Mount (aw)	50mm Distance (aw)	200mm Distance (aw)	125	0.02	0.10	0.52	250	0.08	0.25	0.80	500	0.20	0.60	0.92	1000	0.50	0.90	0.80	2000	0.80	0.95	0.90	4000	0.95	0.90	0.95
Frequency (Hz)	Direct Mount (aw)	50mm Distance (aw)	200mm Distance (aw)																										
125	0.02	0.10	0.52																										
250	0.08	0.25	0.80																										
500	0.20	0.60	0.92																										
1000	0.50	0.90	0.80																										
2000	0.80	0.95	0.90																										
4000	0.95	0.90	0.95																										

COLOURS ECHOBORD® 12MM

Due to the nature of the material, surface and colour deviations are possible.

ECHOBORD® 12MM CATEGORY I



ECHOBORD® 12MM CATEGORY II





ECHOBOARD® 24MM

EchoBoard® 24mm is a high-quality sound absorber with an α_w of up to 1.00 and a NRC of up to 0.95, which can be used for ceilings, walls, on tables or freely in space.

Absorption coefficient: α_w 1.00, class A

NAME	COLOUR	ARTICLE	W x H x D (in mm)	UNIT	PET-BOTTLES
EchoBoard® 24mm	105	PET24REC105000A	1800x2380x24	1 pce	303
EchoBoard® 24mm	111	PET24REC111000A	1800x2380x24	1 pce	303
EchoBoard® 24mm	133	PET24REC133000A	1800x2380x24	1 pce	303
EchoBoard® 24mm	155	PET24REC155000A	1800x2380x24	1 pce	303
EchoBoard® 24mm	183	PET24REC183000A	1800x2380x24	1 pce	303
EchoBoard® 24mm	185	PET24REC185000A	1800x2380x24	1 pce	303
EchoBoard® 24mm	204	PET24REC204000A	1800x2380x24	1 pce	303
EchoBoard® 24mm	244	PET24REC244000A	1800x2380x24	1 pce	303
EchoBoard® 24mm	245	PET24REC245000A	1800x2380x24	1 pce	303
EchoBoard® 24mm	263	PET24REC263000A	1800x2380x24	1 pce	303
EchoBoard® 24mm	372	PET24REC372000A	1800x2380x24	1 pce	303
EchoBoard® 24mm	523	PET24REC523000A	1800x2380x24	1 pce	303
EchoBoard® 24mm	563	PET24REC563000A	1800x2380x24	1 pce	303
EchoBoard® 24mm	592	PET24REC592000A	1800x2380x24	1 pce	303
EchoBoard® 24mm	675	PET24REC675000A	1800x2380x24	1 pce	303
EchoBoard® 24mm	784	PET24REC784000A	1800x2380x24	1 pce	303
EchoBoard® 24mm	801	PET24REC801000A	1800x2380x24	1 pce	303
EchoBoard® 24mm	809	PET24REC809000A	1800x2380x24	1 pce	303
EchoBoard® 24mm	833	PET24REC833000A	1800x2380x24	1 pce	303
EchoBoard® 24mm	852	PET24REC852000A	1800x2380x24	1 pce	303
EchoBoard® 24mm	975	PET24REC975000A	1800x2380x24	1 pce	303

ECHOBOARD® 24MM

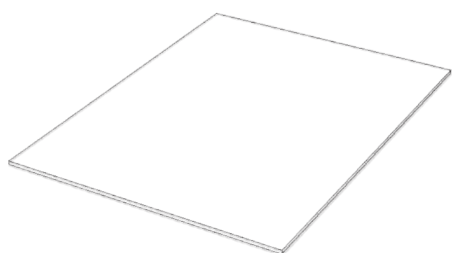

DATA SHEET ECHOBOARD® 24MM

EchoBoard® 24mm is a high quality sound absorber with an aw of up to 1.00 and a NRC of up to 0.95, which can be used for acoustic ceilings, walls, office desks or room dividers.

DESCRIPTION	EchoBoard® 24mm																												
DIMENSIONS	1800mm (± 1mm) x 2380mm (± 1mm)																												
COMPOSITION	100% PET (> 50% recycled PET)																												
PET BOTTLES* PER PANEEL	303 PET Bottles *The number of PET bottles refers to 500ml PET bottles with a bottle weight of 24g.																												
WEIGHT	3600g/m ² (± 10%)																												
MATERIAL THICKNESS	24mm																												
LIGHTFASTNESS ISO 105-B02-1994	> 7																												
FIRE TEST EN 13501	B-s2, d0																												
VOC EMISSIONS ASTM D5116	< 0.5mg/m ² /h																												
FORMALDEHYDE EMISSIONS ASTM D5116	< 0.1mg/m ² /h																												
ENVIRONMENTAL CERTIFICATIONS	eco1 Minergie-Eco Cradle to Cradle Certified® Bronze M1 emission-free materials																												
SOUND ABSORPTION DIN EN ISO 11654 ASTM C423	aw 0.50 (direct mount) aw 0.65 (50mm wall/ceiling distance) aw 1.00 (200mm wall/ceiling distance) NRC = 0.70 (direct mount) NRC = 0.80 (50mm wall/ceiling distance) NRC = 0.95 (200mm wall/ceiling distance)																												
COLOURS	21																												
SOUND ABSORPTION GRAPH	<p>The graph plots the Sound Absorption Coefficient (Y-axis, 0.00 to 1.20) against Frequency in Hertz (X-axis, 125 to 4000 Hz). Three data series are shown: direct mount (green line), 50mm distance (yellow line), and 200mm distance (blue line). All series show an overall upward trend, with the 200mm distance configuration consistently providing the highest absorption across most frequencies, peaking at 1.00 between 2000 Hz and 4000 Hz.</p> <table border="1"> <caption>Approximate data points from the Sound Absorption Graph</caption> <thead> <tr> <th>Frequency (Hz)</th> <th>Direct Mount (Green)</th> <th>50mm Distance (Yellow)</th> <th>200mm Distance (Blue)</th> </tr> </thead> <tbody> <tr> <td>125</td> <td>0.02</td> <td>0.15</td> <td>0.52</td> </tr> <tr> <td>250</td> <td>0.18</td> <td>0.35</td> <td>0.85</td> </tr> <tr> <td>500</td> <td>0.65</td> <td>0.85</td> <td>0.95</td> </tr> <tr> <td>1000</td> <td>0.85</td> <td>1.05</td> <td>0.88</td> </tr> <tr> <td>2000</td> <td>1.00</td> <td>0.98</td> <td>0.95</td> </tr> <tr> <td>4000</td> <td>1.05</td> <td>0.98</td> <td>0.98</td> </tr> </tbody> </table>	Frequency (Hz)	Direct Mount (Green)	50mm Distance (Yellow)	200mm Distance (Blue)	125	0.02	0.15	0.52	250	0.18	0.35	0.85	500	0.65	0.85	0.95	1000	0.85	1.05	0.88	2000	1.00	0.98	0.95	4000	1.05	0.98	0.98
Frequency (Hz)	Direct Mount (Green)	50mm Distance (Yellow)	200mm Distance (Blue)																										
125	0.02	0.15	0.52																										
250	0.18	0.35	0.85																										
500	0.65	0.85	0.95																										
1000	0.85	1.05	0.88																										
2000	1.00	0.98	0.95																										
4000	1.05	0.98	0.98																										

COLOURS ECHOBOARD® 24MM

Due to the nature of the material, surface and colour deviations are possible.

ECHOBOARD® 24MM CATEGORY I



ECHOBOARD® 24MM CATEGORY II



ECHOCOUSTIC®

The special EchoCoustic® absorber is the ideal material for direct mounting on walls or ceilings without spacing or substructure. The 3-layer EchoCoustic® achieves an excellent absorption levels of α_w 0.80 and NRW 0.85 with a thickness of only 25mm. EchoCoustic® can be easily applied with spray adhesive, the white core material remains intentionally visible or concealed by a profile frame. EchoCoustic® is available in 34 colours, as an additional design element a two-colour effect can be created by spacing the panels.



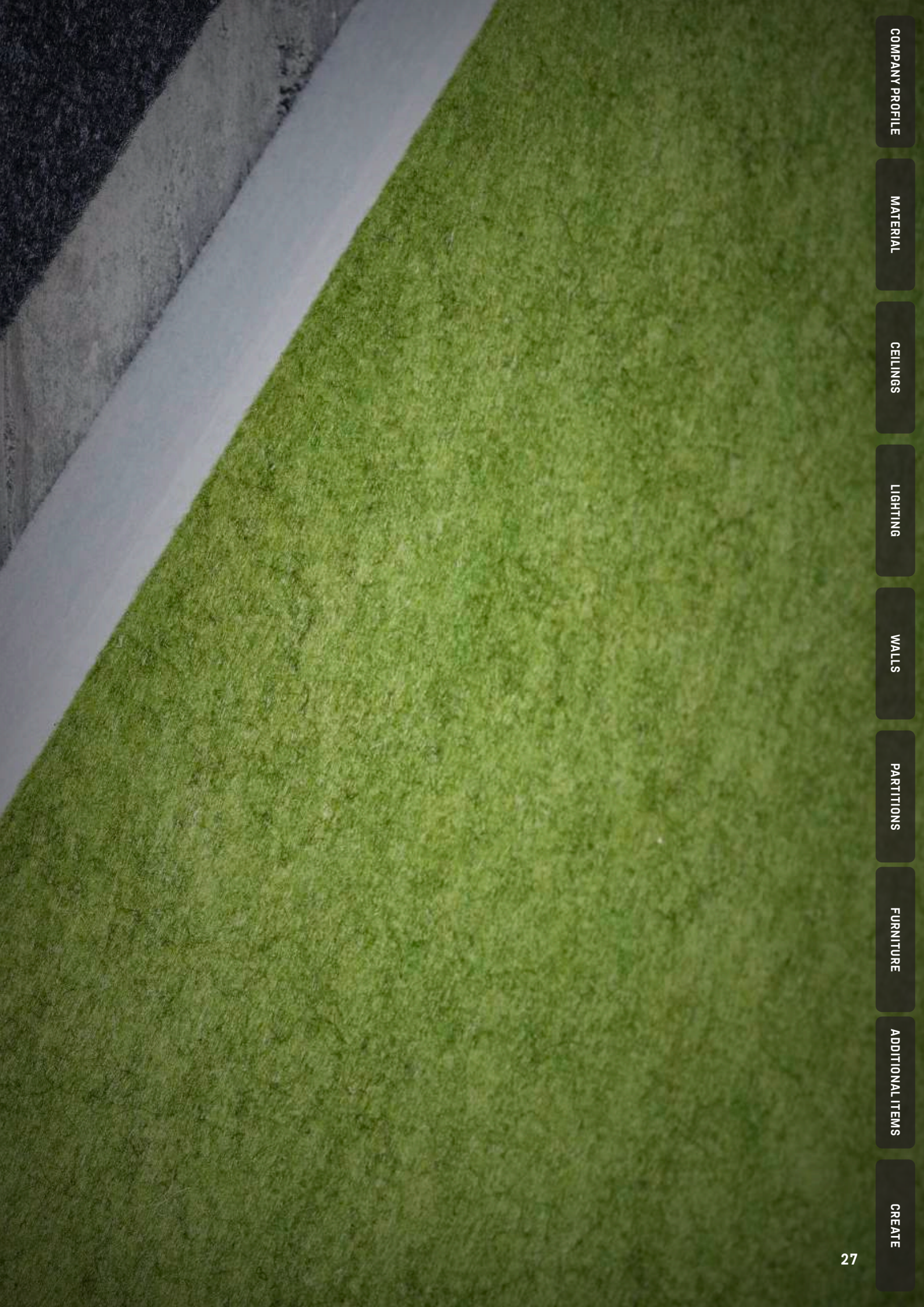

COMPANY PROFILE

MATERIAL

CEILING

LIGHTING

WALLS

PARTITIONS

FURNITURE

ADDITIONAL ITEMS

CREATE



ECHOCOUSTIC® 25MM

EchoCoustic® 25mm is a high quality sound absorber with an aw of up to 0.90 and a NRC of up to 0.90, which can be mounted on walls and ceilings without spacing.

Absorption coefficient: aw 0.90, class A

Discover our EchoCoustic® 25mm PROFILE edge profiles! ([Page 167](#))

NAME	COLOUR	ARTICLE	W x H x D (in mm)	UNIT	PET-BOTTLES
EchoCoustic® 25mm	124	PET25REC124000A	1190x2700x25	1 pce	177
EchoCoustic® 25mm	130	PET25REC130000A	1190x2700x25	1 pce	177
EchoCoustic® 25mm	137	PET25REC137000A	1190x2700x25	1 pce	177
EchoCoustic® 25mm	141	PET25REC141000A	1190x2700x25	1 pce	177
EchoCoustic® 25mm	142	PET25REC142000A	1190x2700x25	1 pce	177
EchoCoustic® 25mm	143	PET25REC143000A	1190x2700x25	1 pce	177
EchoCoustic® 25mm	144	PET25REC144000A	1190x2700x25	1 pce	177
EchoCoustic® 25mm	145	PET25REC145000A	1190x2700x25	1 pce	177
EchoCoustic® 25mm	152	PET25REC152000A	1190x2700x25	1 pce	177
EchoCoustic® 25mm	154	PET25REC154000A	1190x2700x25	1 pce	177
EchoCoustic® 25mm	158	PET25REC158000A	1190x2700x25	1 pce	177
EchoCoustic® 25mm	160	PET25REC160000A	1190x2700x25	1 pce	177
EchoCoustic® 25mm	164	PET25REC164000A	1190x2700x25	1 pce	177
EchoCoustic® 25mm	166	PET25REC166000A	1190x2700x25	1 pce	177
EchoCoustic® 25mm	168	PET25REC168000A	1190x2700x25	1 pce	177
EchoCoustic® 25mm	202	PET25REC202000A	1190x2700x25	1 pce	177
EchoCoustic® 25mm	227	PET25REC227000A	1190x2700x25	1 pce	177
EchoCoustic® 25mm	238	PET25REC238000A	1190x2700x25	1 pce	177
EchoCoustic® 25mm	239	PET25REC239000A	1190x2700x25	1 pce	177
EchoCoustic® 25mm	914	PET25REC914000A	1190x2700x25	1 pce	177
EchoCoustic® 25mm	915	PET25REC915000A	1190x2700x25	1 pce	177
EchoCoustic® 25mm	916	PET25REC916000A	1190x2700x25	1 pce	177
EchoCoustic® 25mm	917	PET25REC917000A	1190x2700x25	1 pce	177
EchoCoustic® 25mm	923	PET25REC923000A	1190x2700x25	1 pce	177
EchoCoustic® 25mm	925	PET25REC925000A	1190x2700x25	1 pce	177
EchoCoustic® 25mm	929	PET25REC929000A	1190x2700x25	1 pce	177
EchoCoustic® 25mm	931	PET25REC931000A	1190x2700x25	1 pce	177
EchoCoustic® 25mm	932	PET25REC932000A	1190x2700x25	1 pce	177
EchoCoustic® 25mm	941	PET25REC941000A	1190x2700x25	1 pce	177
EchoCoustic® 25mm	946	PET25REC946000A	1190x2700x25	1 pce	177
EchoCoustic® 25mm	948	PET25REC948000A	1190x2700x25	1 pce	177
EchoCoustic® 25mm	953	PET25REC953000A	1190x2700x25	1 pce	177
EchoCoustic® 25mm	966	PET25REC966000A	1190x2700x25	1 pce	177
EchoCoustic® 25mm	991	PET25REC991000A	1190x2700x25	1 pce	177

ECHOCOUSTIC® 25MM

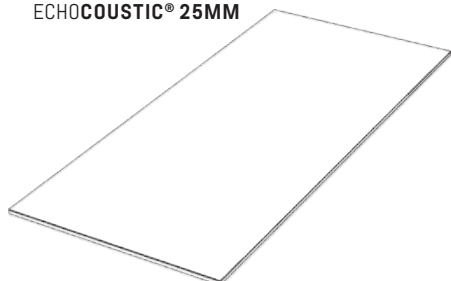

DATA SHEET ECHOCOUSTIC® 25MM

EchoCoustic® is a high quality sound absorber with an aw of up to 0.90 and a NRC of up to 0.90, which can be mounted on walls and ceilings without spacing.

NAME	EchoCoustic® 25mm																					
DIMENSIONS	1190mm (± 1mm) x 2700mm (± 1mm)																					
COMPOSITION	100% PET (<50% recycled PET)																					
PET-BOTTLES* PER PANEL	177 PET-Bottles *The number of PET bottles refers to 500ml PET bottles with a bottle weight of 24g.																					
WEIGHT	2650g/m ² (± 10%)																					
MATERIAL THICKNESS	25mm (± 2mm)																					
LIGHT FASTNESS ISO 105-B02	> 6																					
FIRE PROTECTION EN 13501	B-s1, d0																					
VOC EMISSIONS CDPH STANDARD METHOD V1.1	< 1/2 Chronic Reference Exposure Level																					
FORMALDEHYDE EMISSIONS CDPH STANDARD METHOD V1.1	< 100ppm																					
ENVIRONMENTAL CERTIFICATIONS	eco1 Minergie-Eco Greentag GreenRate Level A M1 emission-free materials																					
ABSORPTION LEVEL ISO 11654 ASTM C423	aw = 0.80 (direct mount) aw = 0.90 (400mm wall/ceiling distance) NRC = 0.85 (direct mount) NRC = 0.90 (400mm wall/ceiling distance)																					
COLOURS	34																					
ABSORPTION GRAPH	<p>The graph plots the Sound Absorption Coefficient (Y-axis, 0.00 to 1.20) against Frequency in Hertz (X-axis, 125 to 4000). Two lines are shown: a green line for 'direct mount' and an orange line for '400mm' distance. The green line starts at ~0.10 at 125 Hz and rises to ~1.00 at 4000 Hz. The orange line starts at ~0.75 at 125 Hz, peaks at ~0.90 at 300 Hz, dips to ~0.75 at 500 Hz, and then stays between 0.90 and 1.00 up to 4000 Hz.</p> <table border="1"> <caption>Approximate data points from the Absorption Graph</caption> <thead> <tr> <th>Frequency (Hz)</th> <th>Sound Absorption Coefficient (direct mount)</th> <th>Sound Absorption Coefficient (400mm)</th> </tr> </thead> <tbody> <tr><td>125</td><td>0.10</td><td>0.75</td></tr> <tr><td>250</td><td>0.45</td><td>0.90</td></tr> <tr><td>500</td><td>0.85</td><td>0.75</td></tr> <tr><td>1000</td><td>1.00</td><td>0.90</td></tr> <tr><td>2000</td><td>1.05</td><td>0.95</td></tr> <tr><td>4000</td><td>1.00</td><td>0.90</td></tr> </tbody> </table>	Frequency (Hz)	Sound Absorption Coefficient (direct mount)	Sound Absorption Coefficient (400mm)	125	0.10	0.75	250	0.45	0.90	500	0.85	0.75	1000	1.00	0.90	2000	1.05	0.95	4000	1.00	0.90
Frequency (Hz)	Sound Absorption Coefficient (direct mount)	Sound Absorption Coefficient (400mm)																				
125	0.10	0.75																				
250	0.45	0.90																				
500	0.85	0.75																				
1000	1.00	0.90																				
2000	1.05	0.95																				
4000	1.00	0.90																				

COLOURS ECHOCOUSTIC® 25MM

Due to the nature of the material, surface and colour deviations are possible.



ECHOCOUSTIC® 25MM CATEGORY I



ECHOCOUSTIC® 25MM CATEGORY II



- COMPANY PROFILE
- MATERIAL
- CEILING
- LIGHTING
- WALLS
- PARTITIONS
- FURNITURE
- ADDITIONAL ITEMS
- CREATE

ECHOFLAKES®

With the Zero Waste goal, ECHO**JAZZ** products are taken back and shredded together with offcuts into EchoFlakes®. Filled with these flakes, the EchoTower® increases the acoustic well-being and closes the material cycle of the ECHO**JAZZ** products.



COMPANY PROFILE

MATERIAL

CEILING

LIGHTING

WALLS

PARTITIONS

FURNITURE

ADDITIONAL ITEMS

CREATE

Customised high-performance sound absorbers for a noticeable improvement in well-being and room quality. ECHO**JAZZ** products are made from recycled PET bottles. 100% Swiss design, 100% zero waste.





COMPANY PROFILE

MATERIAL

CEILING

LIGHTING

WALLS

PARTITIONS

FURNITURE

ADDITIONAL ITEMS

CREATE



ACOUSTIC PRODUCTS

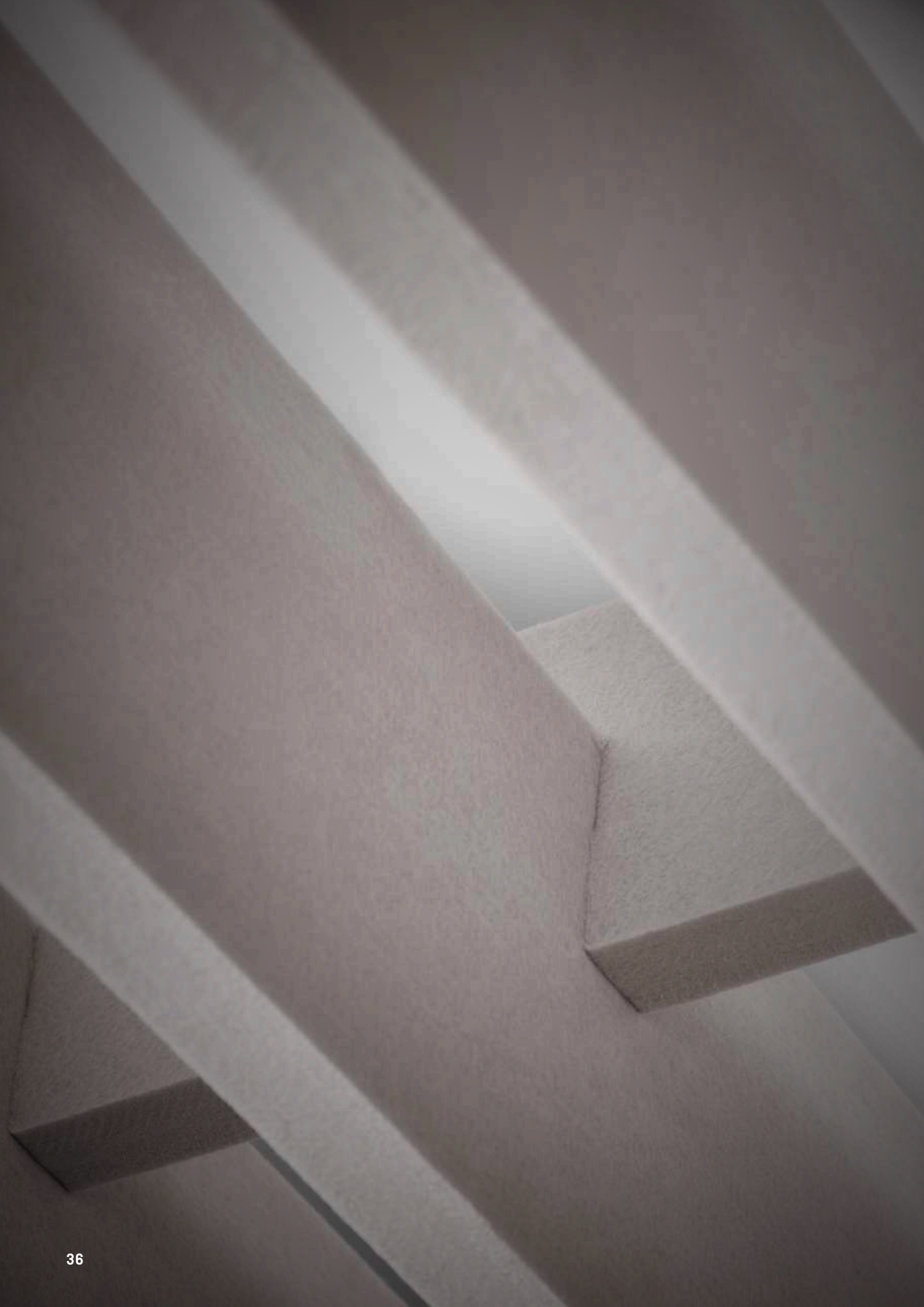



COMPANY PROFILE

MATERIAL

CEILING

LIGHTING

WALLS

PARTITIONS

FURNITURE

ADDITIONAL ITEMS

CREATE

ACOUSTIC-CEILING

Ceilings of rooms often offer the most space for optimising room acoustics. ECHO**JAZZ** acoustic ceilings allow sound absorption for the highest demands, are adapted to the millimetre and can be optimally integrated into any room architecture.



ECHOORBIT®

The EchoOrbit® ceiling sail is the perfect solution to acoustical calm noisy rooms. Three-dimensional diamond facets dampen the noise level and act as a diffuser for sound waves. Additional elements can be added seamlessly thanks to the hexagonal shape, allowing for stunning ceiling designs with spectacular arrangements and colour combinations. Installation is efficient thanks to only one height-adjustable suspension per element and supplied fasteners.

Say goodbye to unwanted noise and immerse yourself in a heavenly, futuristic silence with EchoOrbit®.



COMPANY PROFILE

MATERIAL

CEILING

LIGHTING

WALLS

PARTITIONS

FURNITURE

ADDITIONAL ITEMS

CREATE

ECHOORBIT® 24MM

Acoustic absorber for ceilings with textile surface made from 100% PET. EchoOrbit® is suspended with safety hooks.

Please specify suspension type when ordering.

Absorption coefficient: α_w 1.00, class A

NAME	ARTICLE	W x H x D (in mm)	UNIT	PET-BOTTLES
EchoOrbit® 24mm / Three suspension points	EOR24PLA110127A	1100x1270x109	2 pce	169
EchoOrbit® 24mm / One suspension point	EOR24PLA110127B	1100x1270x109	2 pce	169

ECHOORBIT® 24MM
THREE SUSPENSION POINTS

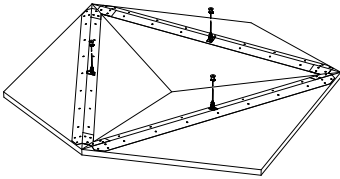

ECHOORBIT® 24MM
ONE SUSPENSION POINT

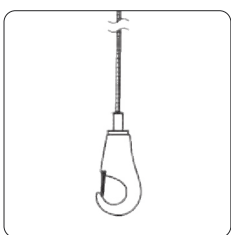
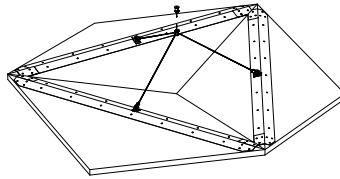

SAFETY HOOK

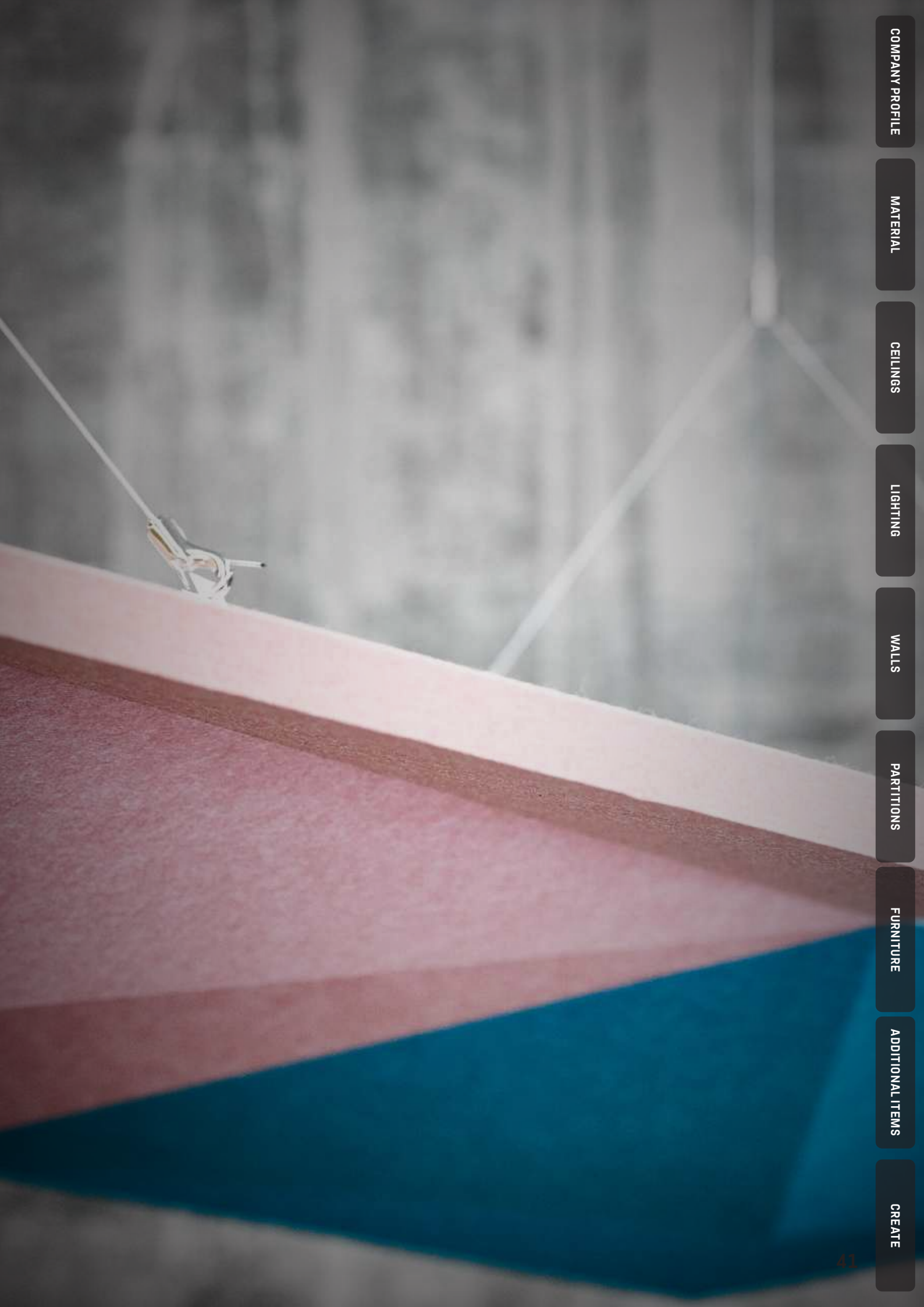

COMPANY PROFILE

MATERIAL

CEILING

LIGHTING

WALLS

PARTITIONS

FURNITURE

ADDITIONAL ITEMS

CREATE



ECHOSAIL®

Acoustic sails are the key to defining room design and improving acoustics over large areas without affecting the layout of the room. The lightweight and maintenance-free elements can be cut to any shape and angle. The EchoSail® is screwed directly and suspended horizontally up to a length of 1000 mm; larger panels are suspended with frames and safety hooks.



COMPANY PROFILE

MATERIAL

CEILING

LIGHTING

WALLS

PARTITIONS

FURNITURE

ADDITIONAL ITEMS

CREATE

ECHOSAIL® 12MM

Acoustic sails in various shapes and surface designs incl. suspension system up to 1500mm. The EchoSail® is suspended directly with screws up to a length of 1000mm. For all shapes over 1000mm long, the EchoSail® is suspended with a frame and safety hooks. The frame is white as standard and can be supplied in other colours to order.

Absorption coefficient: α_w 0.90, class A

Edge finish: 90°, corner radius 200mm

NAME	ARTICLE	W x H x D (in mm)	UNIT	PET-BOTTLES
EchoSail® 12mm BUTTERFLY	ESA12BUT109081A	1091x811x49	3 pce	109
EchoSail® 12mm HEXAGON	ESA12HEX118102A	1180x1078x62	2 pce	99
EchoSail® 12mm RECTANGLE	ESA12REC238118A	2380x1180x62	1 pce	140
EchoSail® 12mm ROUND	ESA12ROU118118A	Ø1180x62	2 pce	109
EchoSail® 12mm SQUARE	ESA12SQU118118A	1180x1180x62	2 pce	139

**ECHOSAIL® 12MM
BUTTERFLY**

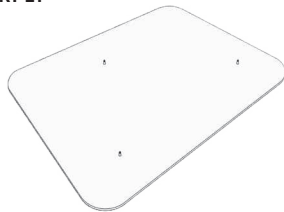

**ECHOSAIL® 12MM
HEXAGON**

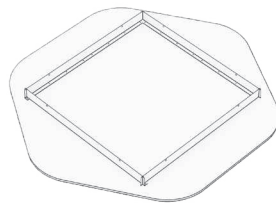

**ECHOSAIL® 12MM
RECTANGLE**

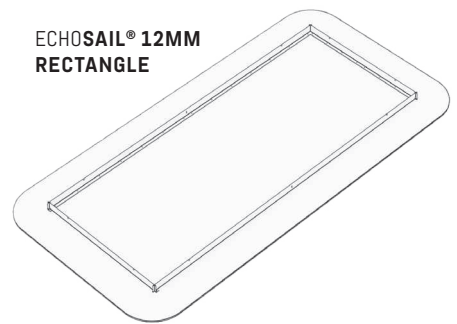

**ECHOSAIL® 12MM
ROUND**

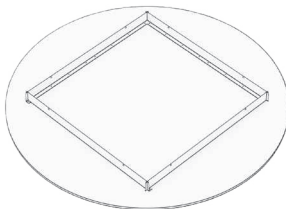

**ECHOSAIL® 12MM
SQUARE**

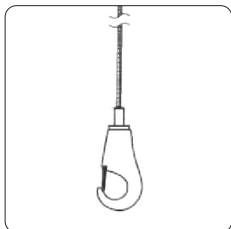
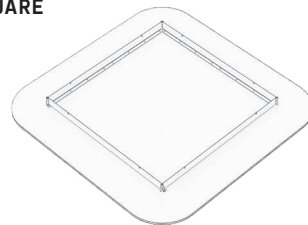

SAFETY HOOK

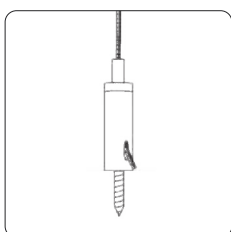

DIRECTLY SCREWED

**ECHOSAIL® 24MM
SQUARE L**

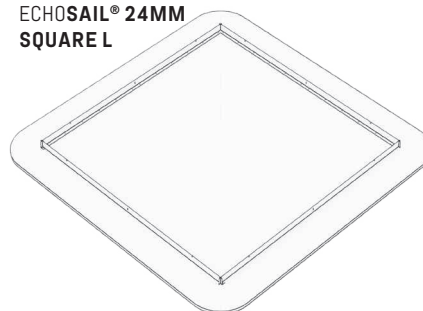

**ECHOSAIL® 24MM
STONE**

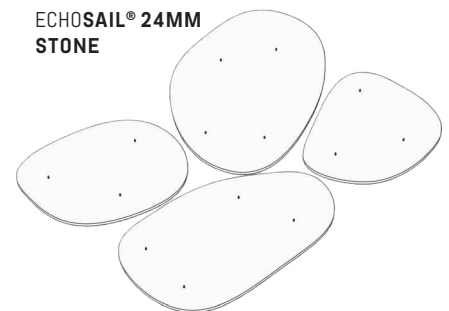

ECHOSAIL® 24MM

Acoustic sails in various shapes and surface designs incl. suspension system up to 1500mm. The EchoSail® is suspended directly with screws up to a length of 1000mm. For all shapes over 1000mm long, the EchoSail® is suspended with a frame and safety hooks. The frame is white as standard and can be supplied in other colours to order.

Absorption coefficient: α_w 1.00, class A

Edge finish: 90°, corner radius 200mm

NAME	ARTICLE	W x H x D (in mm)	UNIT	PET-BOTTLES
EchoSail® 24mm BUTTERFLY M	ESA24BUT109081A	1091x811x74	3 pce	154
EchoSail® 24mm BUTTERFLY L	ESA24BUT127171A	1273x1708x74	2 pce	252
EchoSail® 24mm HEXAGON M	ESA24HEX118102A	1180x1078x74	2 pce	141
EchoSail® 24mm HEXAGON L	ESA24HEX180156A	1800x1645x74	1 pce	165
EchoSail® 24mm RECTANGLE M	ESA24REC238118A	2380x1180x74	1 pce	199
EchoSail® 24mm RECTANGLE L	ESA24REC238180A	2380x1800x74	1 pce	303
EchoSail® 24mm ROUND M	ESA24ROU118118A	Ø1180x61	2 pce	155
EchoSail® 24mm ROUND L	ESA24ROU180180A	Ø1800x74	1 pce	180
EchoSail® 24mm SQUARE M	ESA24SQU118118A	1180x1180x74	2 pce	197
EchoSail® 24mm SQUARE L	ESA24SQU180180A	1800x1800x74	1 pce	230
EchoSail® 24mm STONE	ESA24ST0238180A	954-1530x820-971x61	4 pce	245

**ECHOSAIL® 24MM
BUTTERFLY M**

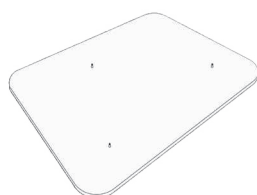

**ECHOSAIL® 24MM
BUTTERFLY L**

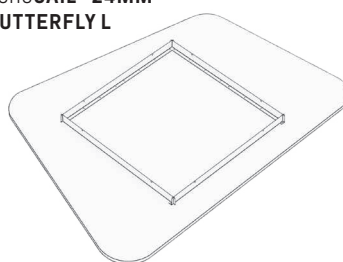

**ECHOSAIL® 24MM
HEXAGON M**

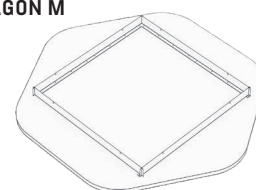

**ECHOSAIL® 24MM
HEXAGON L**

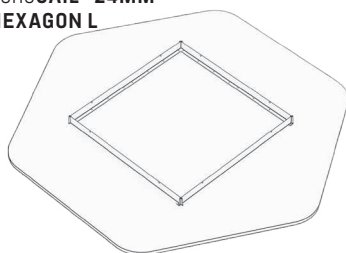

**ECHOSAIL® 24MM
RECTANGLE M**

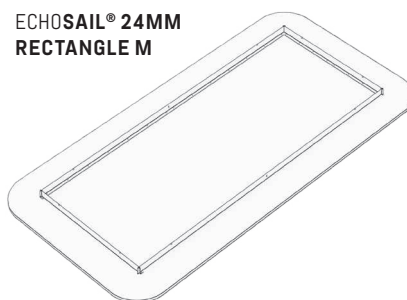

**ECHOSAIL® 24MM
RECTANGLE L**

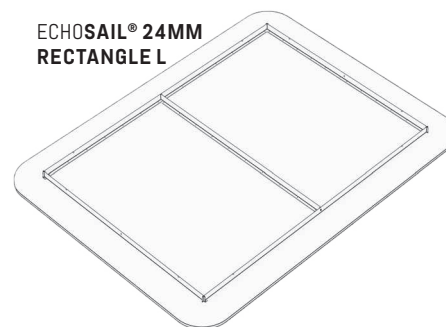

**ECHOSAIL® 24MM
ROUND M**

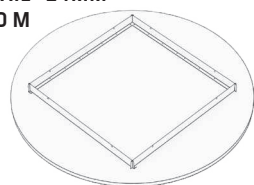

**ECHOSAIL® 24MM
ROUND L**

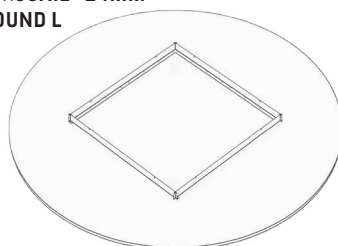

**ECHOSAIL® 24MM
SQUARE M**

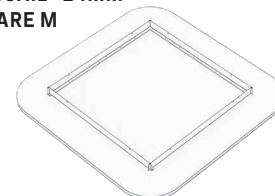



ECHOBaffle®

EchoBaffles® suspended vertically from the ceiling combine efficient acoustic well-being and striking design in open ceilings. It is visibly different from conventional ceilings. The open ceiling concepts also ensure the integration of the building structures in terms of climate technology while optimising the room acoustics at the same time. The inlays are plugged together on site and hooked into the grid ceiling without tools. The very light grid inlays can be easily removed, allowing easy access for maintenance of the building services.

The high acoustic performance of EchoBaffles® effectively dampens sound and “audibly” upgrades rooms with high noise levels. As a customised solution with individual design, the acoustic ceiling becomes a special eye-catcher and lends the room a lot of dynamism.

EchoBaffle® allows ceilings ranging from understated simplicity to dramatic sculptural shapes. The creations of the **ECHOJAZZ** designers are only a starting point, we are happy to work out individual designs on customer request. Complete reusability after use guaranteed – zero waste!



COMPANY PROFILE

MATERIAL

CEILING

LIGHTING

WALLS

PARTITIONS

FURNITURE

ADDITIONAL ITEMS

CREATE

ECHOBaffle® 12MM



Acoustic baffles consisting of baffle blades incl. substructure and suspension.

Absorption coefficient: α_w 0.45

When ordering custom designed EchoBaffle® ceilings additional specifications are needed. (Page 169)

You can always find the latest designs on our website: www.echojazz.com/echobaffle.

EchoBoard® 12mm colours are available depending on stock.

Individual EchoBaffle® solutions available on request!

NAME	ARTICLE	W x H x D (in mm)	UNIT	PET-BOTTLES
EchoBaffle® 12mm PLAIN M	EBA12PLA139160A	1390x1600x235	1 Pce	158
EchoBaffle® 12mm PLAIN L	EBA12PLA278160A	2780x1600x235	1 Pce	201
EchoBaffle® 12mm CORNER M	EBA12COR139160A	1390x1600x240	1 Pce	120
EchoBaffle® 12mm CORNER L	EBA12COR278160A	2780x1600x240	1 Pce	306
EchoBaffle® 12mm VOGUE M	EBA12VOG139160A	1390x1600x290	1 Pce	118
EchoBaffle® 12mm VOGUE L	EBA12VOG278160A	2780x1600x290	1 Pce	227
EchoBaffle® 12mm CUSTOM DESIGN	ESP12BAFFLE000A	According to design	1 Pce	

**ECHOBaffle® 12MM
PLAIN M**

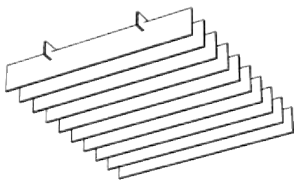

**ECHOBaffle® 12MM
PLAIN L**

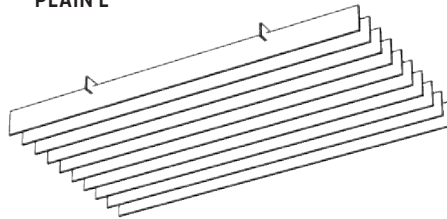

**ECHOBaffle® 12MM
CORNER M**

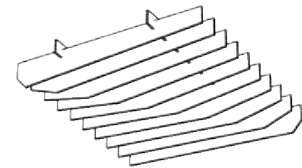

**ECHOBaffle® 12MM
CORNER L**

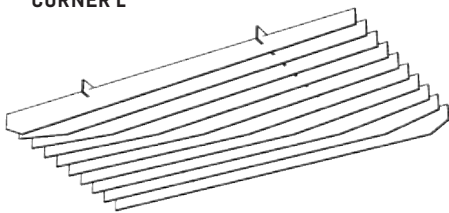

**ECHOBaffle® 12MM
VOGUE M**

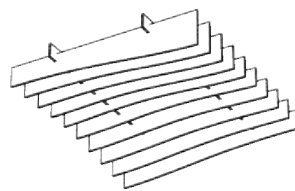

**ECHOBaffle® 12MM
VOGUE L**

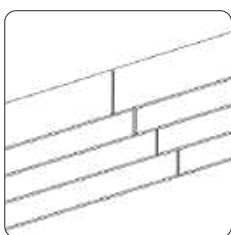
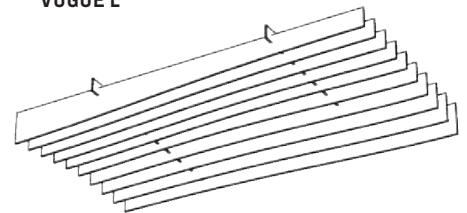

CLOSED EDGE

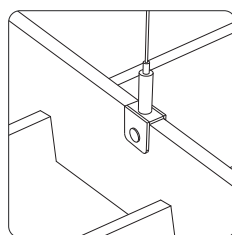

DIRECT SUSPENSION

ECHOBAFFLE® 24MM

Acoustic baffles consisting of baffle blades incl. substructure and suspension.

Absorption coefficient: α_w 0.50

When ordering custom designed EchoBaffle® ceilings additional specifications are needed. (Page 169)

You can always find the latest designs on our website: www.echojazz.com/echobaffle.

Individual EchoBaffle® solutions available on request!



NAME	ARTICLE	W x H x D (in mm)	UNIT	PET-BOTTLES
EchoBaffle® 24mm PLAIN M	EBA24PLA108160A	1075x1600x235	1 Pce	147
EchoBaffle® 24mm PLAIN L	EBA24PLA236160A	2360x1600x235	1 Pce	307
EchoBaffle® 24mm CORNER M	EBA24COR108160A	1075x1600x240	1 Pce	124
EchoBaffle® 24mm CORNER L	EBA24COR236160A	2360x1600x240	1 Pce	240
EchoBaffle® 24mm VOGUE M	EBA24VOG108160A	1075x1600x290	1 Pce	124
EchoBaffle® 24mm VOGUE L	EBA24VOG236160A	2360x1600x290	1 Pce	250
EchoBaffle® 12mm CUSTOM DESIGN	ESP24BAFFLE000A	According to design	1 Pce	

**ECHOBAFFLE® 24MM
PLAIN M**

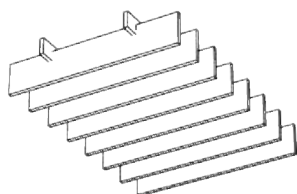

**ECHOBAFFLE® 24MM
PLAIN L**

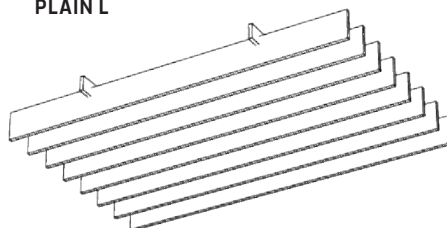

**ECHOBAFFLE® 24MM
CORNER M**

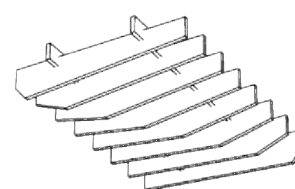

**ECHOBAFFLE® 24MM
CORNER L**

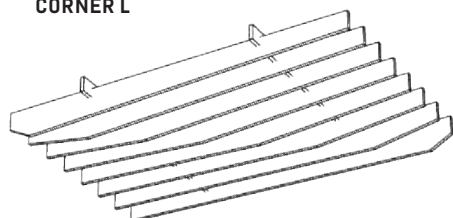

**ECHOBAFFLE® 24MM
VOGUE M**

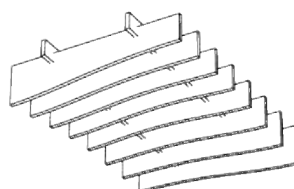

**ECHOBAFFLE® 24MM
VOGUE L**

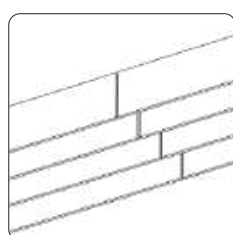
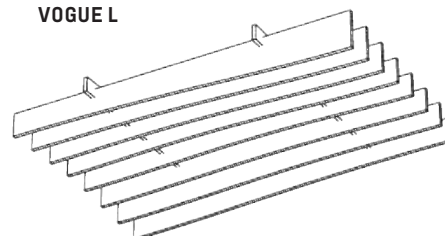

CLOSED EDGE

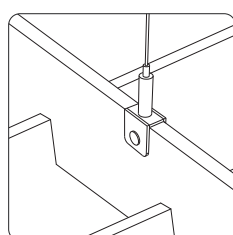

DIRECT SUSPENSION



ECHOGRID®

EchoGrid® is a new inlay for grid ceilings. It's an innovative concept for grid ceilings that is visibly different from conventional ceilings. The high acoustic performance noticeably and audibly upgrades heavily frequented rooms. The inlays are plugged together on site and hooked into the grid ceiling without tools. The very light grid inlays can be easily removed, allowing easy access for maintenance of the building services. Complete reusability after use guaranteed - zero waste!

EchoGrid® allows ceilings ranging from understated simplicity to dramatic sculptural shapes. The creations of the **ECHOJAZZ** designers are only a starting point, we are happy to work out individual designs on customer request.

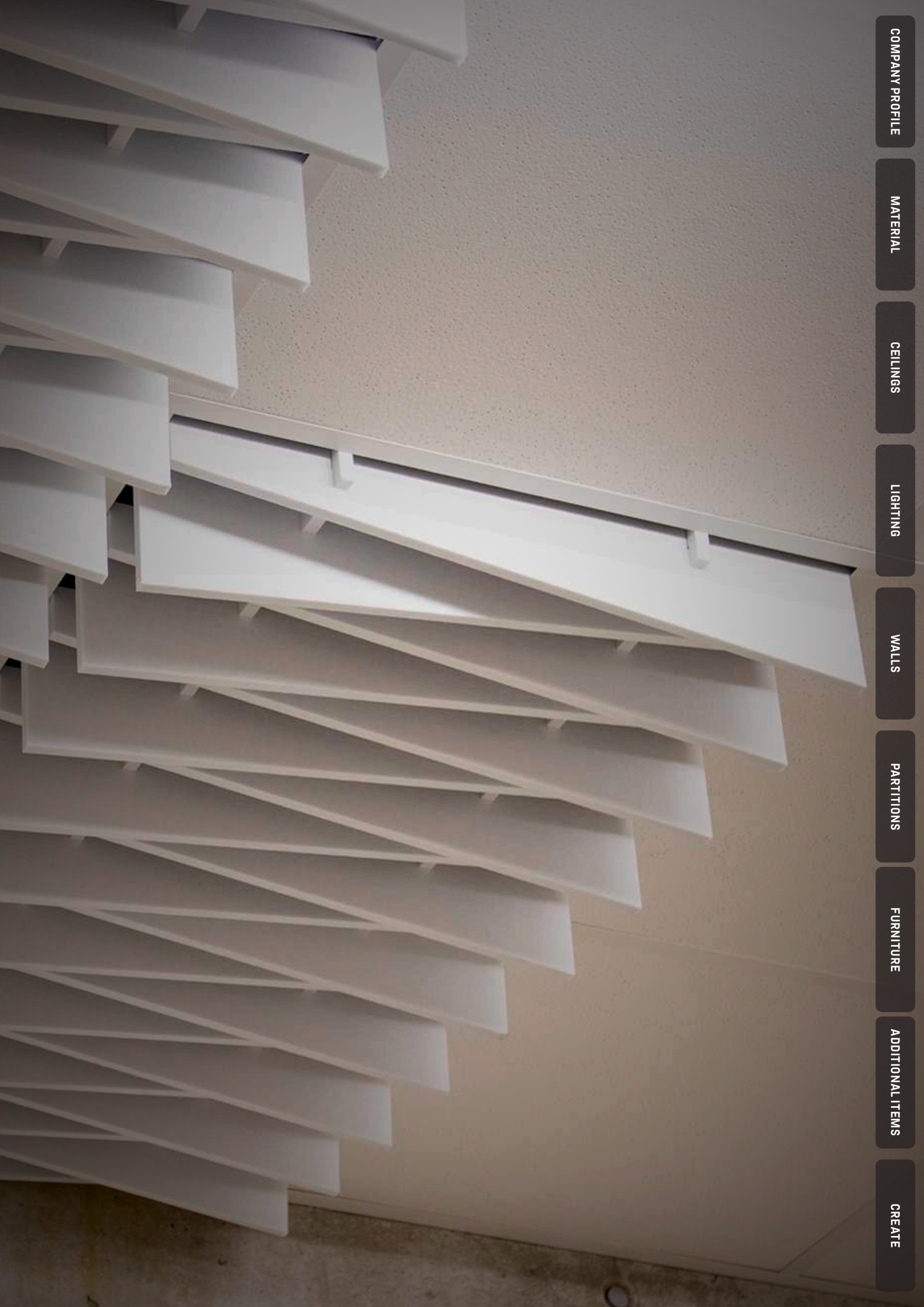

COMPANY PROFILE

MATERIAL

CEILING

LIGHTING

WALLS

PARTITIONS

FURNITURE

ADDITIONAL ITEMS

CREATE

ECHOGRID® 12MM

High-performance acoustic inlay for ceiling grids with textile surface made of 100% PET.

Absorption coefficient: α_w 0.30 - 0.90, class A.

Suitable for grid sizes 625x625mm & 1250x625mm with profile width 24mm

Minimum distance between ceiling and grid: 200mm

Individual EchoGrid® solutions on request!

You can always find the latest designs on our website www.echojazz.com/echogrid



NAME	ARTICLE	W x H x D (in mm)	UNIT	PET-BOTTLES
EchoGrid® 12mm PLAIN 625 P	EGR12PLA063063P	619x65x600	6 Pce	129
EchoGrid® 12mm PLAIN 1250 P	EGR12PLA125063P	1245x65x600	3 Pce	132
EchoGrid® 12mm PLAIN 625 S	EGR12PLA063063S	619x65x600	12 Pce	149
EchoGrid® 12mm PLAIN 1250 S	EGR12PLA125063S	1245x65x600	6 Pce	152
EchoGrid® 12mm MATRIX 625 P	EGR12MAT063063P	619x72x599	8 Pce	144
EchoGrid® 12mm MATRIX 1250 P	EGR12MAT125063P	1245x72x599	4 Pce	145
EchoGrid® 12mm MATRIX 625 S	EGR12MAT063063S	619x72x599	11 Pce	147
EchoGrid® 12mm MATRIX 1250 S	EGR12MAT125063S	1245x72x599	6 Pce	162
EchoGrid® 12mm BLADES 625 P	EGR12BLA063063P	619x130x600	4 Pce	104
EchoGrid® 12mm BLADES 1250 P	EGR12BLA125063P	1250x130x600	2 Pce	115
EchoGrid® 12mm BLADES 625 S	EGR12BLA063063S	619x130x600	8 Pce	116
EchoGrid® 12mm BLADES 1250 S	EGR12BLA125063S	1250x130x600	4 Pce	120
EchoGrid® 12mm CROSSING 625 P	EGR12CR0063063P	619x120x600	4 Pce	108
EchoGrid® 12mm CROSSING 1250 P	EGR12CR0125063P	1250x150x600	2 Pce	131
EchoGrid® 12mm CROSSING 625 S	EGR12CR0063063S	619x120x600	8 Pce	121
EchoGrid® 12mm CROSSING 1250 S	EGR12CR0125063S	1245x150x600	4 Pce	144
EchoGrid® 12mm TILE 625	EGR12TIL063063A	619x12x605	8 Pce	150
EchoGrid® 12mm TILE 1250	EGR12TIL125063A	1244x12x605	4 Pce	151

ECHOGRID® 24MM

High-performance acoustic inlay for ceiling grids with textile surface made of 100% PET.

Absorption coefficient: α_w 0.50 - 1.00, class A.

Suitable for grid sizes 625x625mm & 1250x625mm with profile width 24mm

Minimum distance between ceiling and grid: 200mm

Individual EchoGrid® solutions on request!

You can always find the latest designs on our website www.echojazz.com/echogrid



NAME	ARTICLE	W x H x D (in mm)	UNIT	PET-BOTTLES
EchoGrid® 24mm TILE 625	EGR24TIL063063A	619x24x605	9 pce	239
EchoGrid® 24mm TILE 1250	EGR24TIL125063A	1244x24x605	4 pce	213

**ECHOGRID® 12MM
PLAIN 625 PREMIUM**



**ECHOGRID® 12MM
PLAIN 1250 PREMIUM**



**ECHOGRID® 12MM
PLAIN 625 STANDARD**



**ECHOGRID® 12MM
PLAIN 1250 STANDARD**

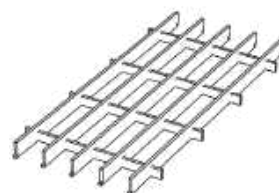

**ECHOGRID® 12MM
MATRIX 625 PREMIUM**



**ECHOGRID® 12MM
MATRIX 1250 PREMIUM**

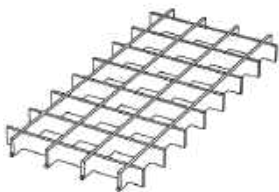

**ECHOGRID® 12MM
MATRIX 625 STANDARD**



**ECHOGRID® 12MM
MATRIX 1250 STANDARD**

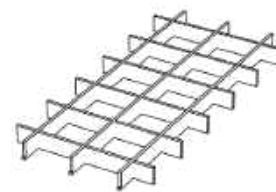

**ECHOGRID® 12MM
BLADES 625 PREMIUM**



**ECHOGRID® 12MM
BLADES 1250 PREMIUM**



**ECHOGRID® 12MM
BLADES 625 STANDARD**



**ECHOGRID® 12MM
BLADES 1250 STANDARD**



**ECHOGRID® 12MM
CROSSING 625 PREMIUM**



**ECHOGRID® 12MM
CROSSING 1250 PREMIUM**

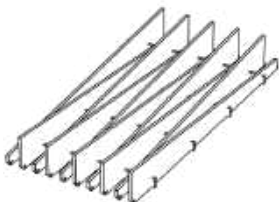

**ECHOGRID® 12MM
CROSSING 625 STANDARD**



**ECHOGRID® 12MM
CROSSING 1250 STANDARD**

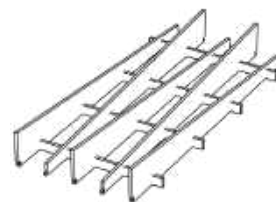

**ECHOGRID® 12MM
TILE 625**



**ECHOGRID® 12MM
TILE 1250**

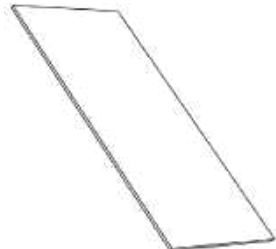

**ECHOGRID® 24MM
TILE 625**



**ECHOGRID® 24MM
TILE 1250**







ACOUSTIC-LIGHTING

Lighting and room acoustics in one: sound-absorbing acoustic luminaires allow individual room design with maximum effect. The **ECHOJAZZ** range includes minimalist integrations with ceiling canopies as well as stand-alone luminaires with a striking design.



ECHOLED® EQ4

The elegant EchoLED® EQ4 task luminaire integrates almost invisibly into the high-performance acoustic ceiling, providing exceptional quality of light. The module offers all the possibilities of digital lighting control and is dimmable with DALI drivers as standard. The acoustic luminaire is supplied ready to plug in and can be easily connected or replaced.

EchoLED® EQ4 combines expertise from the fields of light and acoustics. ECHOJAZZ acoustics in interaction with Bartenbach lighting solutions.

Bartenbach 

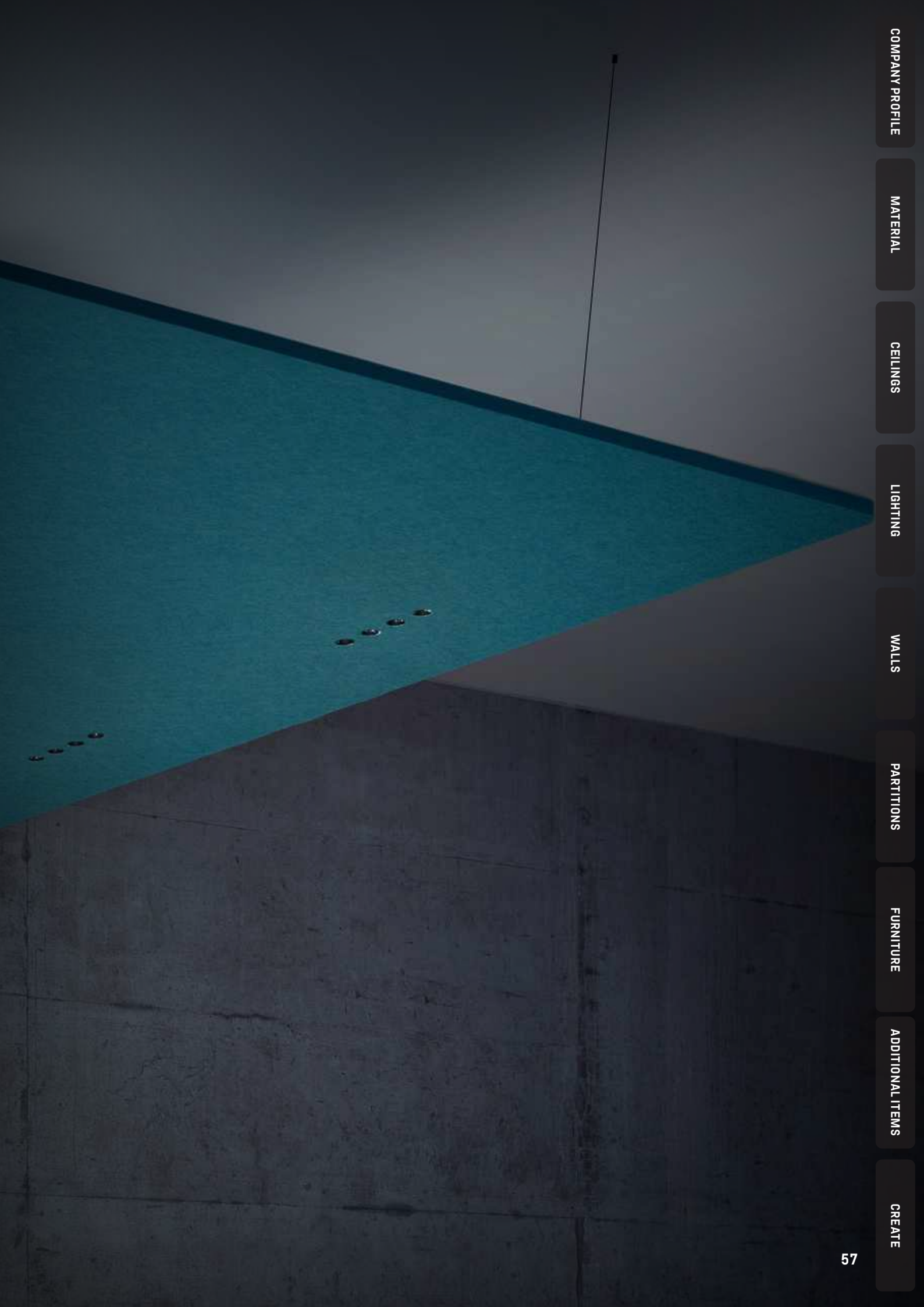

COMPANY PROFILE

MATERIAL

CEILING

LIGHTING

WALLS

PARTITIONS

FURNITURE

ADDITIONAL ITEMS

CREATE

ECHOLED® 24MM EQ4

Acoustic sail with fully integrated lighting with DALI dimming mode incl. substructure and suspension. The EchoLED® EQ4 luminaire is suspended with frame and safety hook. The frame is white as standard and can be supplied in other colours to order. Supplied without plug.

Absorption coefficient: aw 1.00, class A

Edge finish: 90°, corner radius 40mm

Available with ON/OFF and Casambi control on request.

Please specify the type of EchoLED® EQ4 PIN light module when ordering. (Page 171)

NAME	ARTICLE	W x H x D (in mm)	UNIT	PET-BOTTLES
EchoLED® 24mm EQ4 SINGLE M	ELE24EQ1118118A	1180x1180x74	1 pce	99
EchoLED® 24mm EQ4 SINGLE L	ELE24EQ1180180A	1800x1800x74	1 pce	230
EchoLED® 24mm EQ4 DOUBLE M	ELE24EQ2180180A	1800x1800x74	1 pce	230
EchoLED® 24mm EQ4 DOUBLE L	ELE24EQ2238180A	2380x1800x74	1 pce	303
EchoLED® 24mm EQ4 QUAD L	ELE24EQ4238180A	2380x1800x74	1 pce	303

**ECHOLED® 24MM EQ4
SINGLE M**

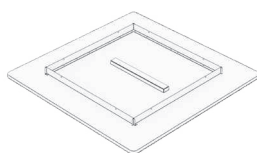

**ECHOLED® 24MM EQ4
SINGLE L**

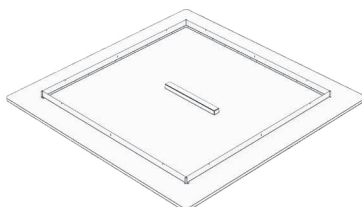

**ECHOLED® 24MM EQ4
DOUBLE M**

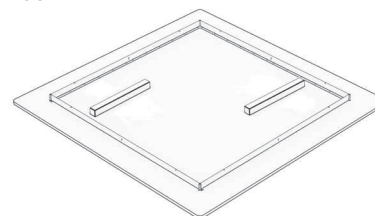

**ECHOLED® 24MM EQ4
DOUBLE L**

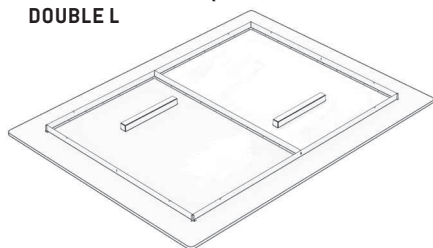

**ECHOLED® 24MM EQ4
QUAD L**

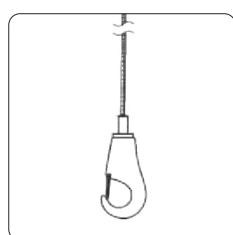
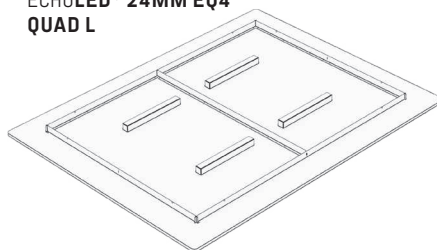

SAFETY HOOK





ECHOLED® CONE

The EchoLED® CONE acoustic pendant light is ideal for open spaces with decorative requirements. The classic cone-shaped lampshade made of EchoBoard® effectively dampens sound. The quality spotlight with black reflector achieves a brightness of minimum 1680 Lumens, with a power consumption of an energy-efficient 20 watt.

EchoLED® CONE is available in five sizes, the lampshade made of PET acoustic material contains up to 360 recycled PET bottles. The ceiling lamp is particularly appealing thanks to the different material thicknesses, the 21 expressive colours and varying designs.



COMPANY PROFILE

MATERIAL

CEILING

LIGHTING

WALLS

PARTITIONS

FURNITURE

ADDITIONAL ITEMS

CREATE

ECHOLED® 12MM CONE

Acoustic pendant luminaire incl. substructure and suspension. Supplied without plug.

Absorption coefficient: α_w 0.90, class A

NAME	ARTICLE	W x H x D (in mm)	UNIT	PET-BOTTLES
EchoLED 12mm CONE XS VERTIGO	ELE12CON040027V	400x273x400	1 Pce	16
EchoLED 12mm CONE XS WAVY	ELE12CON040027W	400x273x400	1 Pce	16
EchoLED 12mm CONE S VERTIGO	ELE12CON060040V	600x403x600	1 Pce	37
EchoLED 12mm CONE S WAVY	ELE12CON060040W	600x403x600	1 Pce	37
EchoLED 12mm CONE M VERTIGO	ELE12CON080053V	800x533x800	1 Pce	66
EchoLED 12mm CONE M WAVY	ELE12CON080053W	800x533x800	1 Pce	66
EchoLED 12mm CONE L VERTIGO	ELE12CON120065V	1200x653x1200	1 Pce	136
EchoLED 12mm CONE L WAVY	ELE12CON120065W	1200x653x1200	1 Pce	136
EchoLED 12mm CONE XL VERTIGO	ELE12CON160085V	1600x853x1600	1 Pce	241
EchoLED 12mm CONE XL WAVY	ELE12CON160085W	1600x853x1600	1 Pce	241

ECHOLED® 12MM CONE XS VERTIGO

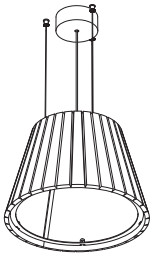

ECHOLED® 12MM CONE XS WAVY

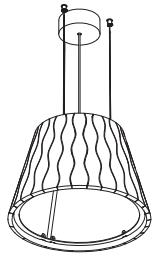

ECHOLED® 12MM CONE S VERTIGO

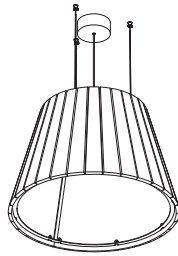

ECHOLED® 12MM CONE S WAVY

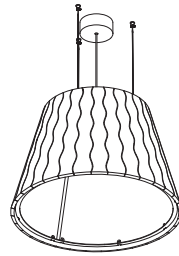

ECHOLED® 12MM CONE M VERTIGO

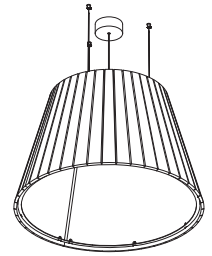

ECHOLED® 12MM CONE M WAVY

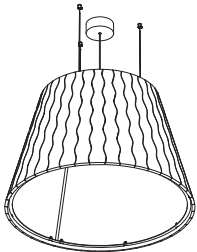

ECHOLED® 12MM CONE L VERTIGO

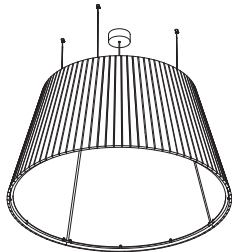

ECHOLED® 12MM CONE L WAVY

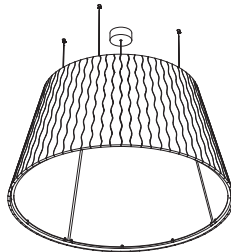

ECHOLED® 12MM CONE XL VERTIGO

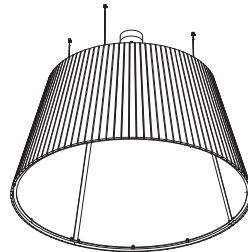

ECHOLED® 12MM CONE XL WAVY

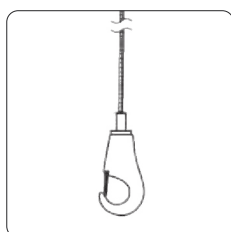
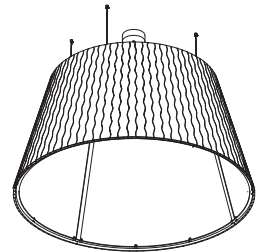

SAFETY HOOK

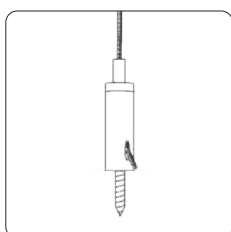

DIRECT SUSPENSION

ECHOLED® 24MM CONE

Acoustic pendant luminaire incl. substructure and suspension. Supplied without plug.

Absorption coefficient: α_w 1.00, class A

NAME	ARTICLE	W x H x D (in mm)	UNIT	PET-BOTTLES
EchoLED 24mm CONE XS WAVY	ELE24CON042028W	424x276x424	1 Pce	24
EchoLED 24mm CONE S WAVY	ELE24CON062041W	624x406x624	1 Pce	55
EchoLED 24mm CONE M WAVY	ELE24CON082054W	824x536x824	1 Pce	99
EchoLED 24mm CONE L WAVY	ELE24CON122066W	1224x656x1224	1 Pce	204
EchoLED 24mm CONE XL WAVY	ELE24CON162086W	1624x856x1624	1 Pce	361

ECHOLED® 24MM CONE
XS WAVY

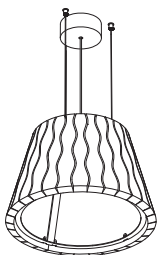

ECHOLED® 24MM CONE
S WAVY

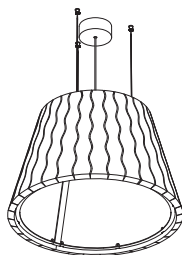

ECHOLED® 24MM CONE
M WAVY

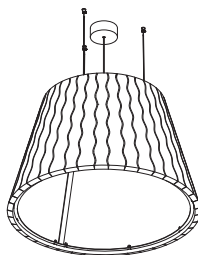

ECHOLED® 24MM CONE
L WAVY

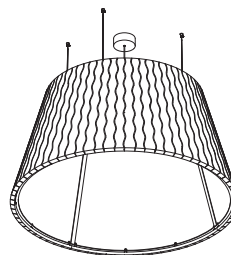

ECHOLED® 24MM CONE
XL WAVY

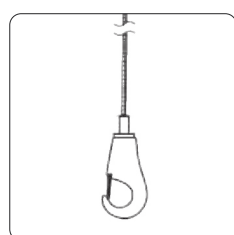
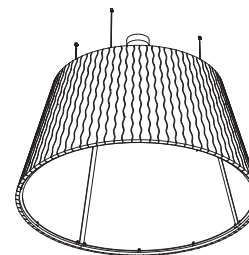

SAFETY HOOK

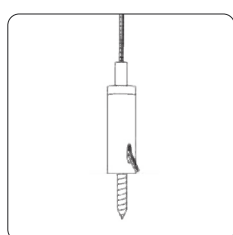

DIRECT SUSPENSION



ECHOLED® UMBRA

The expressive acoustic luminaire is created for high rooms. It is available in two sizes and is ideal for strong acoustic absorption above workstations or conference tables. The EQ4 lighting module from Bartenbach offers all the possibilities of digital lighting control. The ideal distance from the table tops to the EchoLED® UMBRA should not be less than 170cm.

EchoLED® UMBRA combines expertise from the fields of light and acoustics. ECHOJAZZ acoustics in interaction with Bartenbach lighting solutions.

Bartenbach 



COMPANY PROFILE

MATERIAL

CEILING

LIGHTING

WALLS

PARTITIONS

FURNITURE

ADDITIONAL ITEMS

CREATE

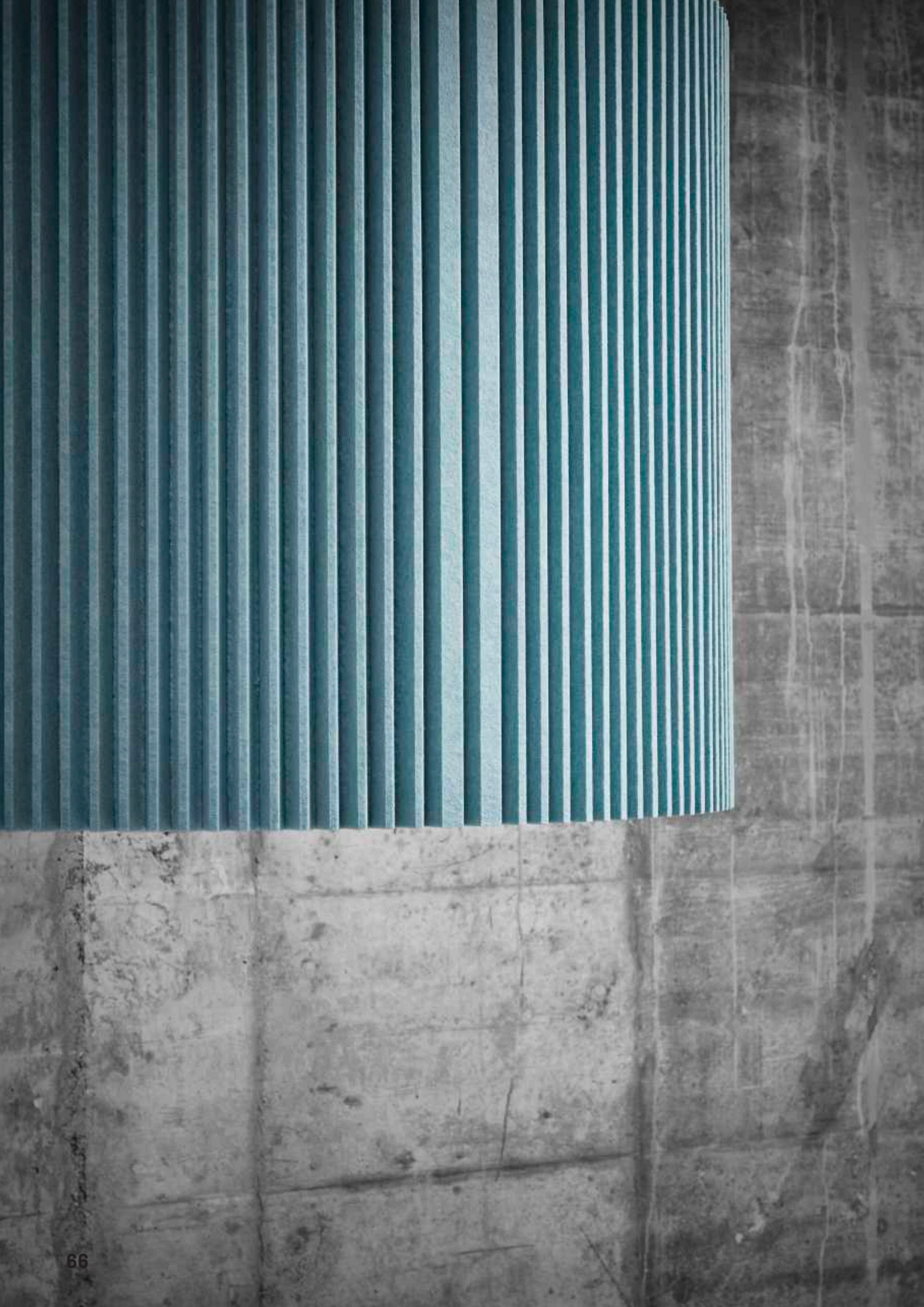

ECHOLED® 24MM UMBRA

Acoustic luminaire with DALI dimming mode incl. substructure and suspension. Supplied without plug.

Absorption coefficient: α_w 1.00, class A.

ON/OFF and Casambi control available on request

On request, the UMBRA L is available in overlengths

When ordering, please specify the type of EchoLED® EQ4 PIN light module. ([Page 171](#))

NAME	ARTICLE	W x H x D (in mm)	UNIT	PET-BOTTLES
EchoLED® 24mm UMBRA M	ELE24UMB078059A	782x590x782	1 pce	117
EchoLED® 24mm UMBRA L	ELE24UMB236059A	2362x590x782	1 pce	300

ECHOLED® 24MM
UMBRA M

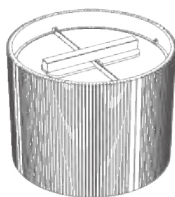

ECHOLED® 24MM
UMBRA L

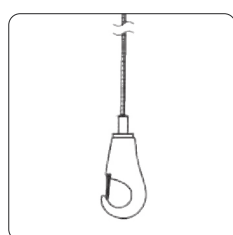
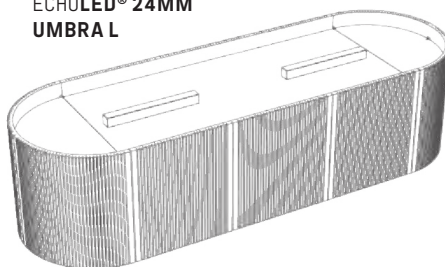

SAFETY HOOK



ECHOLED® LINEAR

For comfort in the workplace, EchoLED® LINEAR was developed with a high-performance absorber and fully integrated linear luminaire. A combination of light quality, functionality and acoustic well-being for employees, paired with durability, maintenance safety and modularity. The fully assembled product only needs to be suspended and connected.



COMPANY PROFILE

MATERIAL

CEILING

LIGHTING

WALLS

PARTITIONS

FURNITURE

ADDITIONAL ITEMS

CREATE



ECHOLED® 24MM LINEAR

Acoustic sail with fully integrated lighting with DALI dimming mode incl. substructure and suspension. Supplied without plug. The EchoLED® LINEAR luminaire is suspended with frame and safety hook. The frame is white as standard and can be supplied in other colours to order.

Absorption coefficient: aw 1.00, class A

Edge finish: 90°, corner radius 200mm

ON/OFF and Casambi control available on request.

Please specify the type of EchoLED® LINEAR LED luminaire module when ordering. (Page 171)

NAME	ARTICLE	W x H x D (in mm)	UNIT	PET-BOTTLES
EchoLED® 24mm LINEAR M2 RECTANGLE L	ELE24LM2238180A	2380x74x1800	1 pce	303
EchoLED® 24mm LINEAR M1 RECTANGLE L	ELE24LM1238180A	2380x74x1800	1 pce	303
EchoLED® 24mm LINEAR M1 SQUARE	ELE24LM1180180A	1800x74x1800	1 pce	230
EchoLED® 24mm LINEAR L2 RECTANGLE L	ELE24LL2238180A	2380x74x1800	1 pce	303
EchoLED® 24mm LINEAR L1 RECTANGLE L	ELE24LL1238180A	2380x74x1800	1 pce	303
EchoLED® 24mm LINEAR L1 RECTANGLE M	ELE24LL1238118A	2380x74x1180	1 pce	199

**ECHOLED® 24MM LINEAR
M2 RECTANGLE L**

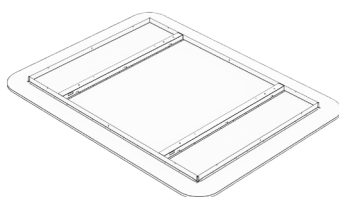

**ECHOLED® 24MM LINEAR
M1 RECTANGLE L**

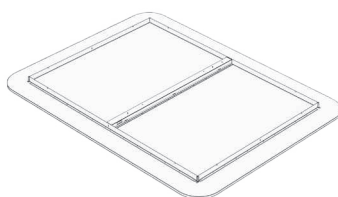

**ECHOLED® 24MM LINEAR
M1 SQUARE**

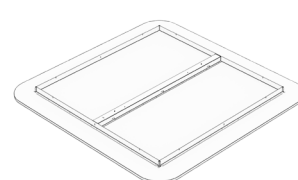

**ECHOLED® 24MM LINEAR
L2 RECTANGLE L**

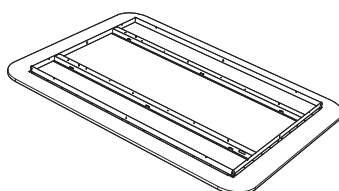

**ECHOLED® 24MM LINEAR
L1 RECTANGLE L**

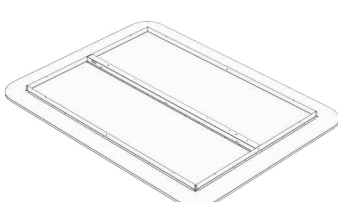

**ECHOLED® 24MM LINEAR
L1 RECTANGLE M**

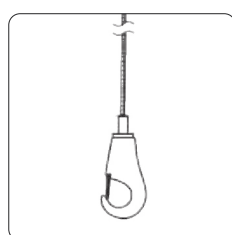
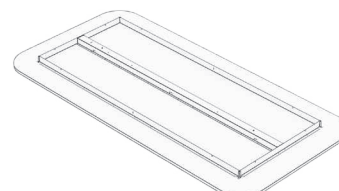

SAFETY HOOK



ECHOLED® BAFFLE

The high-quality linear luminaire is framed in EchoBoard® for improved room acoustics. The quality luminaire developed with Bartenbach is characterised by energy efficiency, easy maintenance and excellent glare protection ($UGR < 15$). The module is DALI dimmable and offers all the possibilities of digital lighting control.

COMPANY PROFILE

MATERIAL

CEILING

LIGHTING

WALLS

PARTITIONS

FURNITURE

ADDITIONAL ITEMS

CREATE

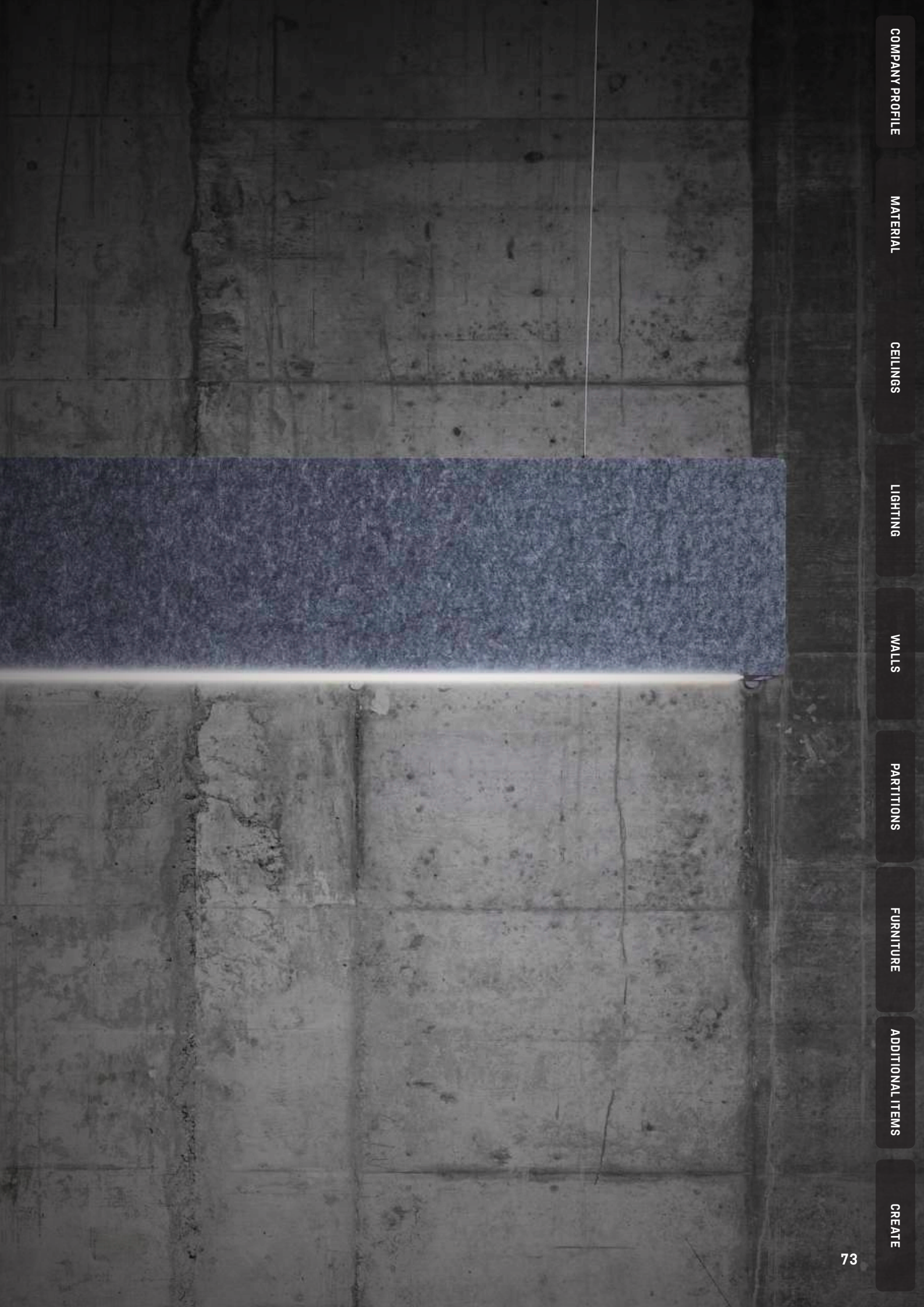



ECHOLED® 24MM BAFFLE®

Acoustic baffle with fully integrated lighting with DALI dimming mode incl. substructure and suspension. Supplied without plug.

Absorption coefficient: [aw 1.00, class A](#)

Edge finish: 90

ON/OFF and Casambi control available on request

NAME	ARTICLE	W x H x D (in mm)	UNIT	PET-BOTTLES
EchoLED® 24mm BAFFLE M	ELE24BAF151029A	1510x109x290	1 pce	65
EchoLED® 24mm BAFFLE L	ELE24BAF209029A	2090x109x290	1 pce	87

ECHOLED® 24MM
BAFFLE M

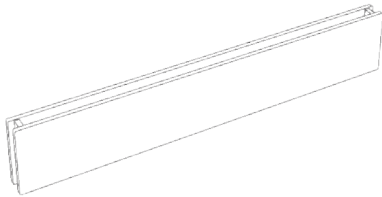

ECHOLED® 24MM
BAFFLE L

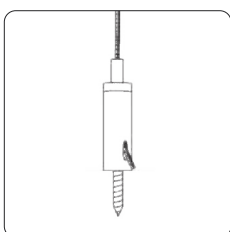
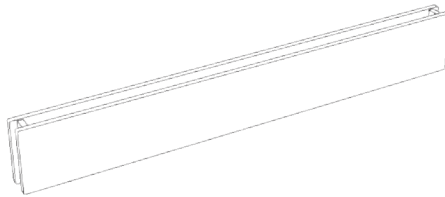

DIRECTLY SCREWED





COMPANY PROFILE

MATERIAL

CEILING

LIGHTING

WALLS

PARTITIONS

FURNITURE

ADDITIONAL ITEMS

CREATE

ACOUSTIC-WALLS

Sound absorbers for wall mounting are an effective alternative to acoustic ceilings, especially in small and narrow rooms: space-saving, individually designable and flexibly applicable, acoustic walls offer sophisticated solutions.



ECHOBaffle® WALL

EchoBaffle® WALL is a new type of wall absorber with three-dimensional slats that come to life as you walk by. EchoBaffle® WALL opens up a new field for acoustic wall design. With changing viewing angles, three-dimensional shapes become visible and disappear again, particularly effective on long walls or corridors.

The EchoBaffles® impress with their simple installation using a tool-free plug-in system. The open structure leaves room for building technology such as sensors, switches or sockets. In addition, individual EchoBaffles® can be removed very easily if required. Discover the new wall solution, which we offer in four designs up to 2.80 metres high.



COMPANY PROFILE

MATERIAL

CEILING

LIGHTING

WALLS

PARTITIONS

FURNITURE

ADDITIONAL ITEMS

CREATE

ECHOBAFFLE® WALL 12MM

Acoustic wall baffles consisting of baffle blades incl. substructure and suspension profiles.

Individual EchoBaffle® solutions available on request!

You can always find the latest designs on our website: www.echojazz.com/echobaffle-wall



NAME	ARTICLE	W x H x D (in mm)	UNIT	PET-BOTTLES
EchoBaffle® WALL 12mm DIAMOND	EBW12DIA280135A	1350x2800x110mm	1 Pce	262
EchoBaffle® WALL 12mm PLAIN	EBW12PLA280135A	1350x2800x113mm	1 Pce	321
EchoBaffle® WALL 12mm TILT	EBW12TIL280135A	1350x2800x92mm	1 Pce	321
EchoBaffle® WALL 12mm WAVE	EBW12WAV280135A	1350x2800x125mm	1 Pce	299

**ECHOBAFFLE® WALL 12MM
DIAMOND**

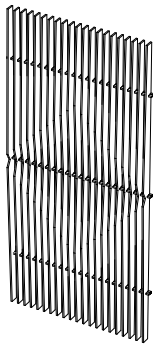

**ECHOBAFFLE® WALL
12MM PLAIN**

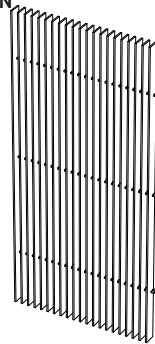

**ECHOBAFFLE® WALL 12MM
TILT**

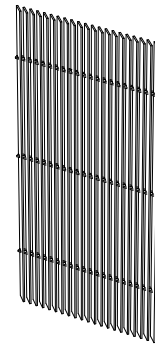

**ECHOBAFFLE® WALL 12MM
WAVE**

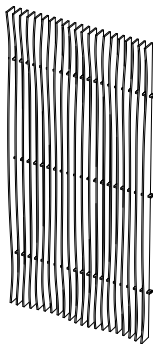

ECHOBaffle® WALL 24MM

Acoustic wall baffles consisting of baffle blades incl. substructure and suspension profiles.

Individual EchoBaffle® solutions available on request!

You can always find the latest designs on our website: www.echojazz.com/echobaffle-wall



NAME	ARTICLE	W x H x D (in mm)	UNIT	PET-BOTTLES
EchoBaffle® WALL 24mm DIAMOND	EBW24DIA238135A	1350x2380x103mm	1 Pce	244
EchoBaffle® WALL 24mm PLAIN	EBW24PLA238135A	1350x2380x103mm	1 Pce	302
EchoBaffle® WALL 24mm TILT	EBW24TIL238135A	1350x2380x94mm	1 Pce	302
EchoBaffle® WALL 24mm WAVE	EBW24WAV238135A	1350x2380x131mm	1 Pce	282

**ECHOBaffle® WALL 24MM
DIAMOND**

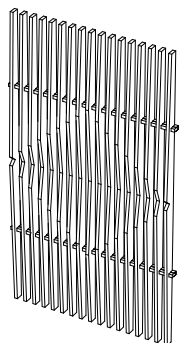

**ECHOBaffle® WALL 24MM
PLAIN**

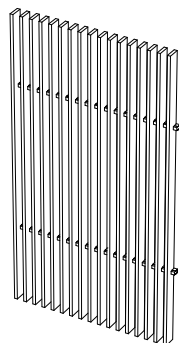

**ECHOBaffle® WALL 24MM
TILT**

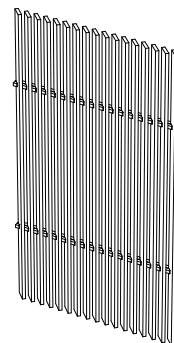

**ECHOBaffle® WALL 24MM
WAVE**

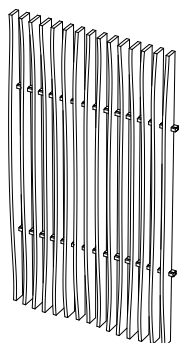



ECHOFIELD®

The EchoField® panels are fixed with a cavity to the wall and provide optimal acoustic performance especially in small and narrow rooms. They are an alternative to EchoSail® ceiling sails, with which they share dimensions and shapes. They are mounted using a powder-coated metal frame that is simply plugged in and suspended using a wall profile.



ECHOFIELD® 12MM

Acoustic panels in various shapes and surface designs incl. wall suspension

Absorption coefficient: α_w 0.90, class A

Edge finish: 90°, corner radius 200mm

NAME	ARTICLE	W x H x D (in mm)	UNIT	PET-BOTTLES
EchoField® 12mm HEXAGON M	EFI12HEX118102A	1180x1078x62	2 pce	99
EchoField® 12mm RECTANGLE M	EFI12REC238118A	2380x1180x62	1 pce	140
EchoField® 12mm ROUND M	EFI12ROU118118A	Ø1180x62	2 pce	109
EchoField® 12mm SQUARE M	EFI12SQU118118A	1180x1180x62	2 pce	139

ECHOFIELD® 12MM
HEXAGON

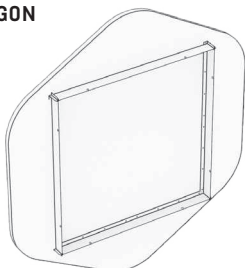

ECHOFIELD® 12MM
RECTANGLE

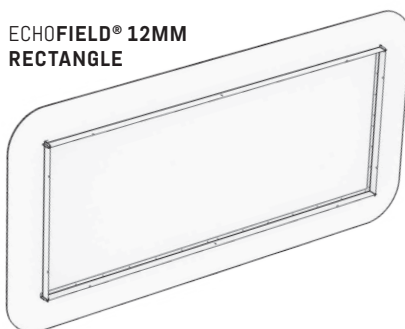

ECHOFIELD®
12MM ROUND

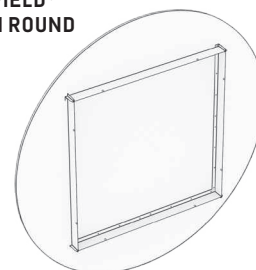

ECHOFIELD®
12MM SQUARE

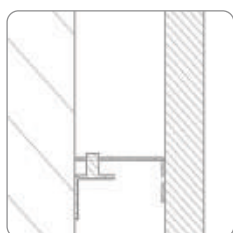
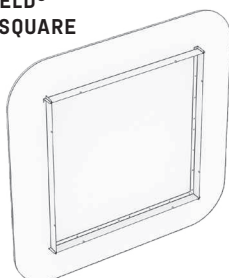

WANDHALTERUNG

ECHOFIELD® 24MM

Acoustic panels in various shapes and surface designs incl. wall suspension

Absorption coefficient: α_w 1.00, class A

Edge finish: 90°, corner radius 200mm

NAME	ARTICLE	W x H x D (in mm)	UNIT	PET-BOTTLES
EchoField® 24mm HEXAGON M	EFI24HEX118102A	1180x1078x74	2 pce	141
EchoField® 24mm HEXAGON L	EFI24HEX180156A	1800x1645x74	1 pce	165
EchoField® 24mm RECTANGLE M	EFI24REC238118A	2380x1180x74	1 pce	199
EchoField® 24mm RECTANGLE L	EFI24REC238180A	2380x1800x74	1 pce	303
EchoField® 24mm ROUND M	EFI24ROU118118A	Ø1180x74	2 pce	155
EchoField® 24mm ROUND L	EFI24ROU180180A	Ø1800x74	1 pce	180
EchoField® 24mm SQUARE M	EFI24SQU118118A	1180x1180x74	2 pce	197
EchoField® 24mm SQUARE L	EFI24SQU180180A	1800x1800x74	1 pce	230

ECHOFIELD® 24MM
HEXAGON M

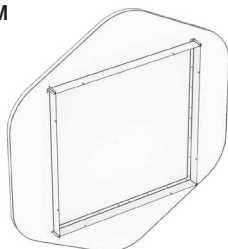

ECHOFIELD® 24MM
HEXAGON L

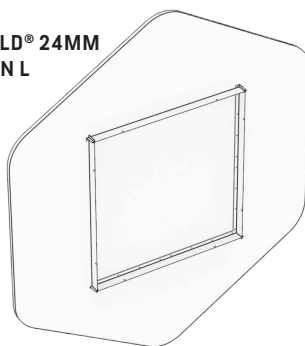

ECHOFIELD® 24MM
RECTANGLE M

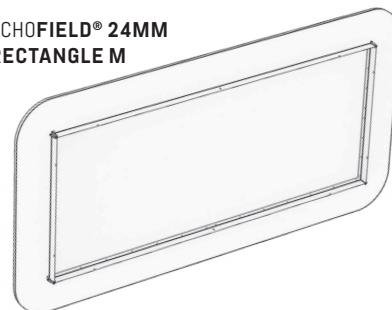

ECHOFIELD® 24MM
RECTANGLE L

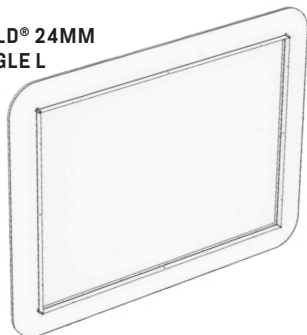

ECHOFIELD® 24MM
ROUND M

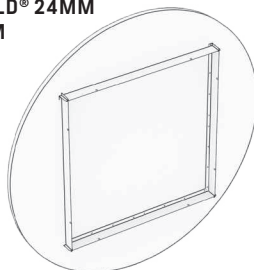

ECHOFIELD® 24MM
ROUND L

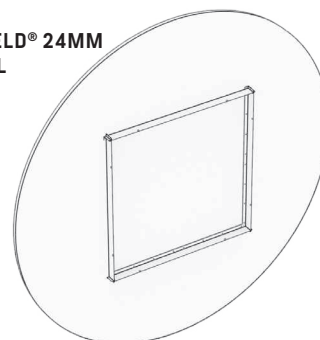

ECHOFIELD® 24MM
SQUARE M

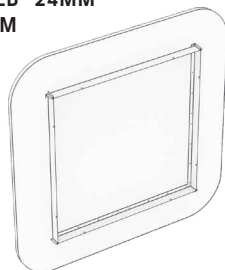

ECHOFIELD® 24MM
SQUARE L

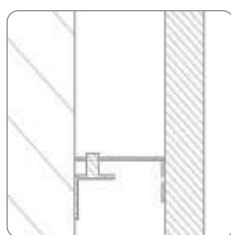
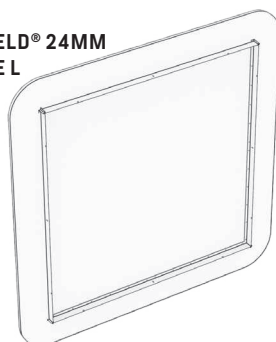

WANDHALTERUNG



ECHOBRIK®

Acoustic wall absorbers offer a good alternative to ceiling elements, especially in small and medium-sized meeting rooms where ceiling absorbers are not effective due to flutter sound. Installation is done using EchoGlue® spray contact adhesive. The acoustic panels can be easily combined with each other and complemented in colour thanks to broken edges.



COMPANY PROFILE

MATERIAL

CEILING

LIGHTING

WALLS

PARTITIONS

FURNITURE

ADDITIONAL ITEMS

CREATE

ECHOBRICK® 12MM

Acoustic wall tiles with bevelling. Installation by means of biodegradable EchoGlue® spray adhesive (included).

Absorption coefficient: α_w 0.30/0.60 (0mm/50mm wall spacing)

Edge finish: 45° bevelling

Special dimensions and designs on request

The latest designs can always be found online at www.echojazz.com/echobrick

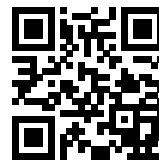

NAME	ARTICLE	W x H x D (in mm)	UNIT	PET-BOTTLES
EchoBrick® 12mm BOLLIWOOD	EBR12BOL280030A	2800x280x12	Set of 4	157
EchoBrick® 12mm BOOMERANG	EBR12BOO0052030A	520x300x12	Set of 40	156
EchoBrick® 12mm CELL	EBR12CEL060069A	600x693x12	Set of 8	125
EchoBrick® 12mm DIAGONAL L	EBR12DIA060060A	600x600x12	Set of 8	144
EchoBrick® 12mm DIAGONAL M	EBR12DIA030030A	300x300x12	Set of 36	162
EchoBrick® 12mm DIAMOND L	EBR12DIM079046A	793x458x12	Set of 12	109
EchoBrick® 12mm DIAMOND M	EBR12DIM040023A	397x229x12	Set of 58	132
EchoBrick® 12mm GRADIENT	EBR12PAT026029A	255x294x12	Set of 48	135
EchoBrick® 12mm HEXAGON L	EBR12HEX070060A	693x600x12	Set of 8	125
EchoBrick® 12mm HEXAGON M	EBR12HEX030026A	294x255x12	Set of 48	191
EchoBrick® 12mm KALEIDO	EBR12KAL060069A	600x693x12	Set of 8	125
EchoBrick® 12mm PLANK M	EBR12PLK030140A	300x1400x12	Set of 8	168
EchoBrick® 12mm PLANK L	EBR12PLK030280A	300x2800x12	Set of 4	168
EchoBrick® 12mm PUZZLE	EBR12PUZ068068A	677x677x12	Set of 10	135
EchoBrick® 12mm SHIELD	EBR12SHI059029A	590x288x12	Set of 20	128
EchoBrick® 12mm TANGRAM	EBR12TAN280120A	2800x1200x12	Set of 35	144
EchoBrick® 12mm WALL L	EBR12WAL060030A	600x300x12	Set of 18	162
EchoBrick® 12mm WALL M	EBR12WAL030015A	300x150x12	Set of 72	162

**ECHOBRICK® 12MM
BOLLIWOOD**

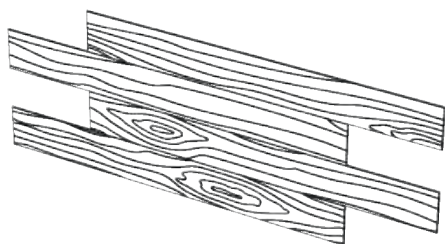

**ECHOBRICK® 12MM
BOOMERANG**

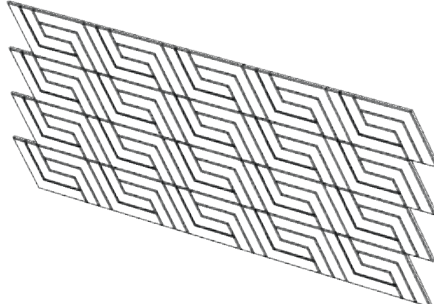

**ECHOBRICK® 12MM
CELL**

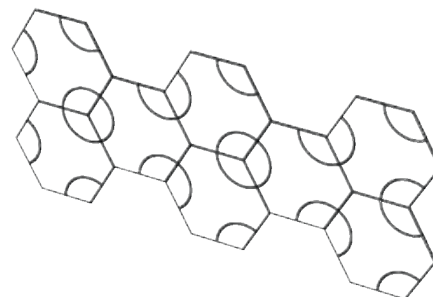

**ECHOBRICK® 12MM
DIAGONAL L**

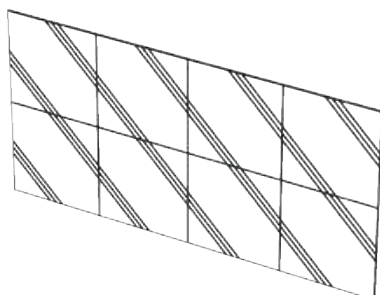

**ECHOBRICK® 12MM
DIAGONAL M**

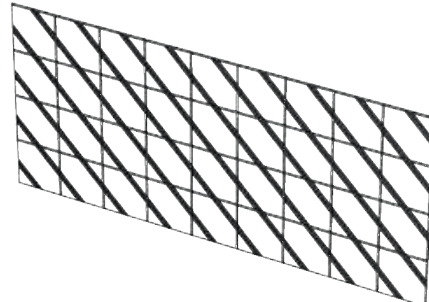

**ECHOBRICK® 12MM
DIAMOND L**

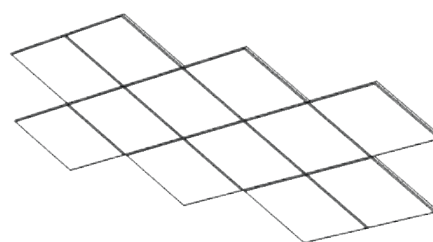

**ECHOBRICK® 12MM
DIAMOND M**

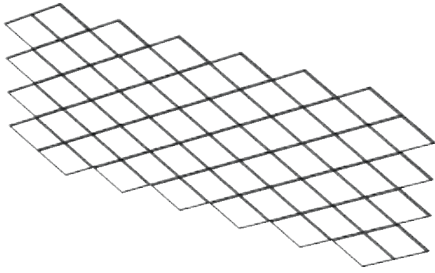

**ECHOBRICK® 12MM
GRADIENT**

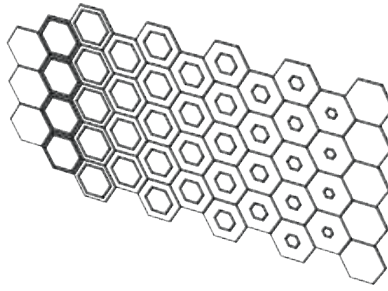

**ECHOBRICK® 12MM
HEXAGON L**

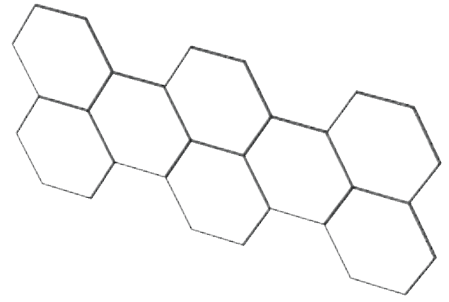

**ECHOBRICK® 12MM
HEXAGON M**

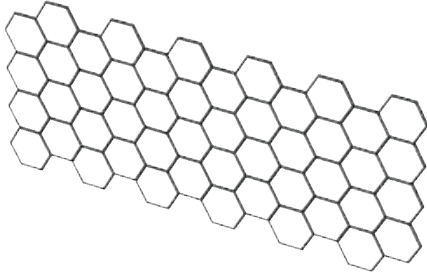

**ECHOBRICK® 12MM
KALEIDO**

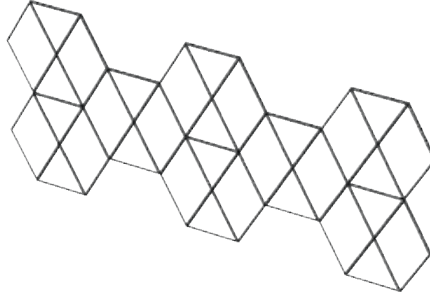

**ECHOBRICK® 12MM
PLANK M**

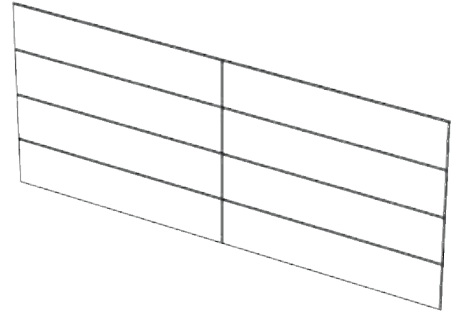

**ECHOBRICK® 12MM
PLANK L**

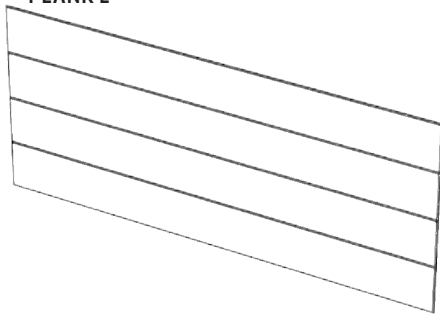

**ECHOBRICK® 12MM
PUZZLE**

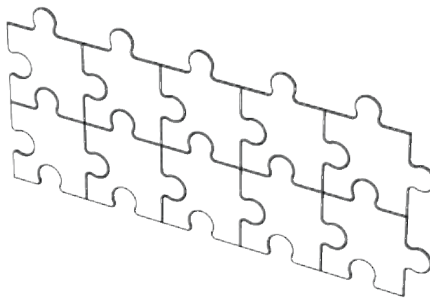

**ECHOBRICK® 12MM
SHIELD**

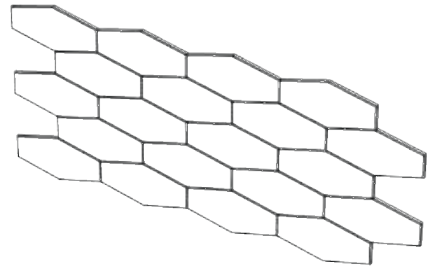

**ECHOBRICK® 12MM
TANGRAM**

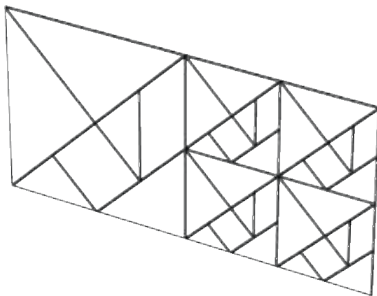

**ECHOBRICK® 12MM
WALL L**

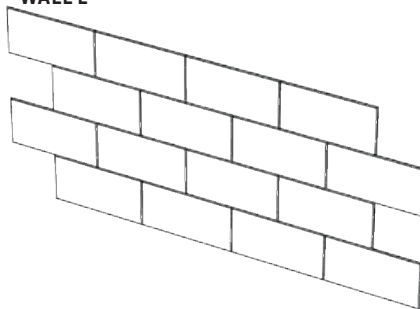

**ECHOBRICK® 12MM
WALL M**

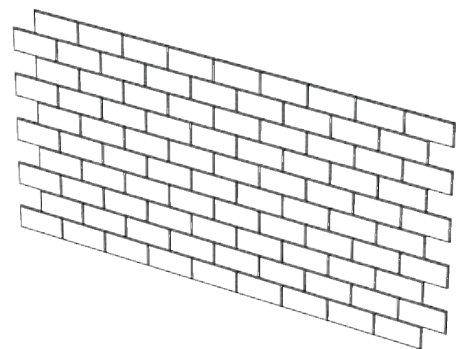

ECHOBRICK® 24MM

Acoustic wall tiles with bevelling. Installation by means of biodegradable EchoGlue® spray adhesive (included).

Absorption coefficient: α_w 0.50/0.65 (0mm/50mm wall spacing)

Edge finish: 45° bevelling

Special dimensions and designs on request

The latest designs can always be found online at www.echojazz.com/echobrick

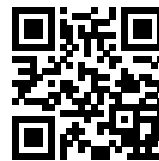

NAME	ARTICLE	W x H x D (in mm)	UNIT	PET-BOTTLES
EchoBrick® 24mm BOLLIWOOD	EBR24BOL240030A	2400x280x24	Set of 6	285
EchoBrick® 24mm BOOMERANG	EBR24B00052030A	520x300x24	Set of 48	265
EchoBrick® 24mm CELL	EBR24CEL060069A	600x693x24	Set of 11	243
EchoBrick® 24mm DIAGONAL L	EBR24DIA060060A	600x600x24	Set of 12	306
EchoBrick® 24mm DIAGONAL M	EBR24DIA030030A	300x300x24	Set of 48	306
EchoBrick® 24mm DIAMOND L	EBR24DIM079046A	793x458x24	Set of 15	193
EchoBrick® 24mm DIAMOND M	EBR24DIM040023A	397x229x24	Set of 77	269
EchoBrick® 24mm GRADIENT	EBR24PAT026029A	255x294x24	Set of 65	259
EchoBrick® 24mm HEXAGON L	EBR24HEX070060A	693x600x24	Set of 11	243
EchoBrick® 24mm HEXAGON M	EBR24HEX030026A	294x255x24	Set of 65	259
EchoBrick® 24mm KALEIDO	EBR24KAL060069A	600x693x24	Set of 11	243
EchoBrick® 24mm PLANK M	EBR24PLK030120A	300x1200x24	Set of 12	306
EchoBrick® 24mm PLANK L	EBR24PLK030240A	300x2400x24	Set of 6	306
EchoBrick® 24mm PUZZLE	EBR24PUZ071071A	677x677x24	Set of 12	230
EchoBrick® 24mm SHIELD	EBR24SHI059029A	590x288x24	Set of 28	253
EchoBrick® 24mm TANGRAM	EBR24TAN238177A	2380x1770x24	Set of 28	296
EchoBrick® 24mm WALL L	EBR24WAL060030A	600x300x24	Set of 24	306
EchoBrick® 24mm WALL M	EBR24WAL030015A	300x150x24	Set of 96	306

**ECHOBRICK® 24MM
BOLLIWOOD**

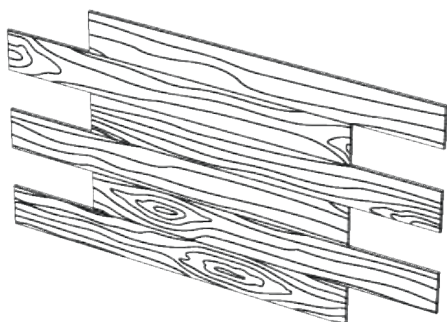

**ECHOBRICK® 24MM
BOOMERANG**

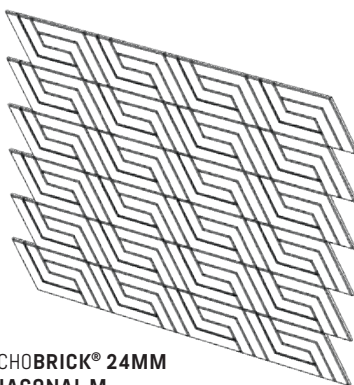

**ECHOBRICK® 24MM
CELL**

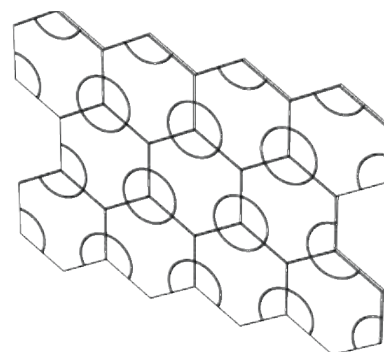

**ECHOBRICK® 24MM
DIAGONAL L**

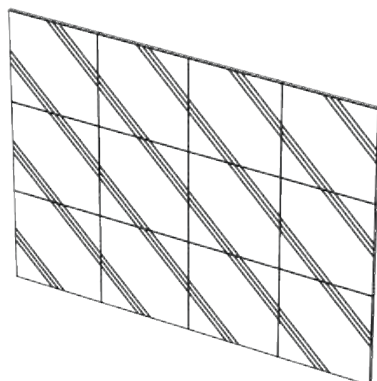

**ECHOBRICK® 24MM
DIAGONAL M**

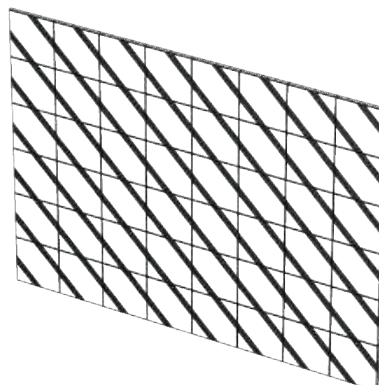

**ECHOBRICK® 24MM
DIAMOND L**

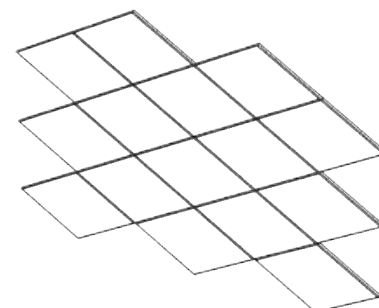

**ECHOBRICK® 24MM
DIAMOND M**

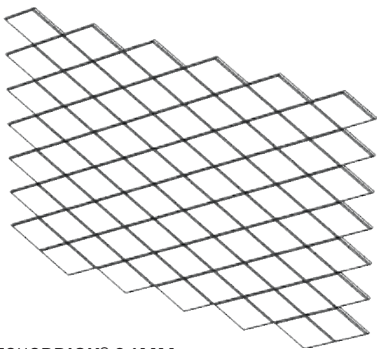

**ECHOBRICK® 24MM
GRADIENT**

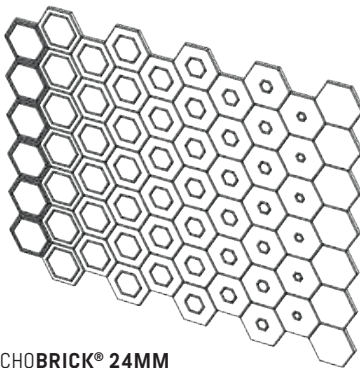

**ECHOBRICK® 24MM
HEXAGON L**

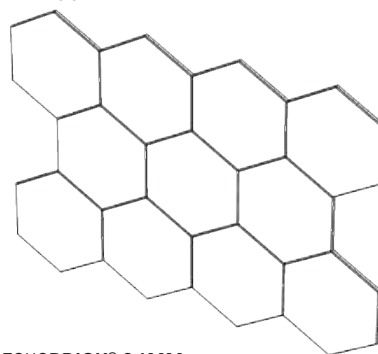

**ECHOBRICK® 24MM
HEXAGON M**



**ECHOBRICK® 24MM
KALEIDO**

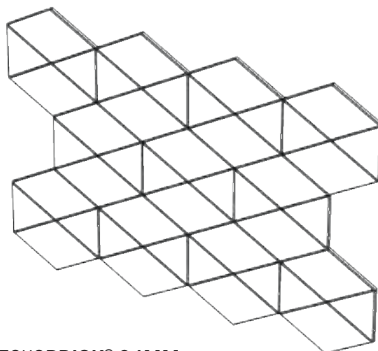

**ECHOBRICK® 24MM
PLANK M**

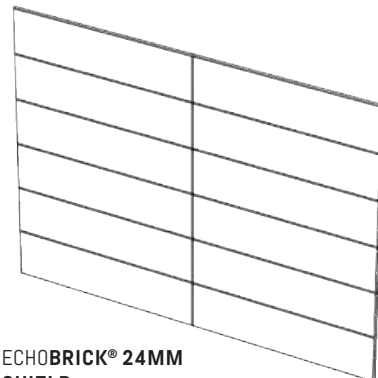

**ECHOBRICK® 24MM
PLANK L**

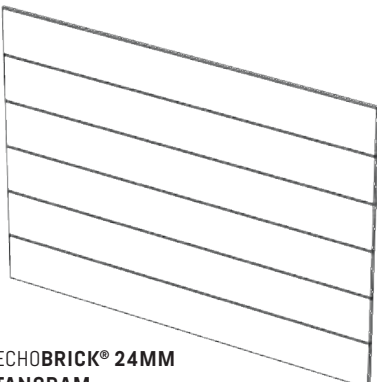

**ECHOBRICK® 24MM
PUZZLE**

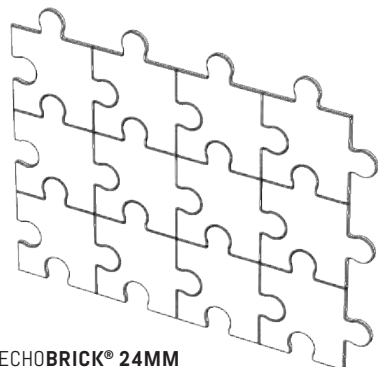

**ECHOBRICK® 24MM
SHIELD**

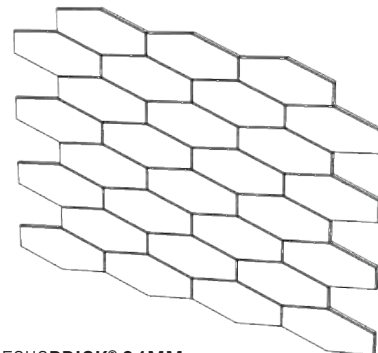

**ECHOBRICK® 24MM
TANGRAM**

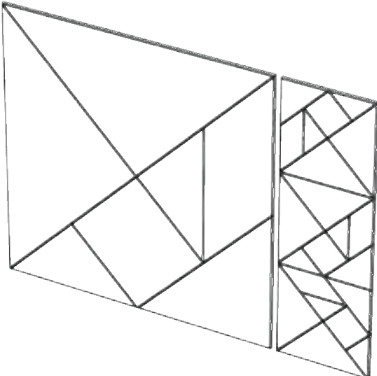

**ECHOBRICK® 24MM
WALL L**

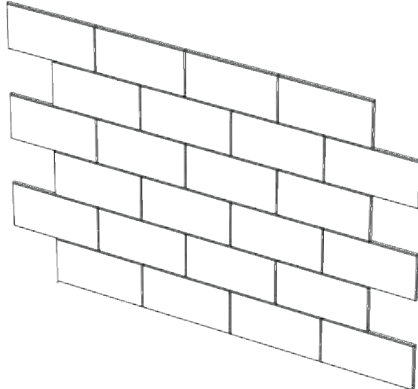

**ECHOBRICK® 24MM
WALL M**

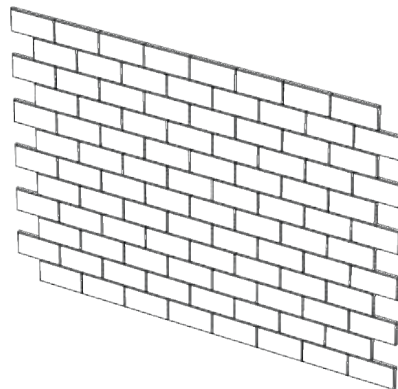

ECHOMONOC®

EchoMonoc® is suitable for large-area wall applications without visible joints. For improved acoustic performance, it is recommended to use the 24mm thick option. ECHO**JAZZ** absorbers made of recycled PET are extremely robust and suitable for regular cleaning and disinfection. Installation is quick and easy with EchoGlue® adhesive contact spray.

Indented carvings break up the monochrome surface. This finishing method creates an indented structure that gives each room its own character.

COMPANY PROFILE

MATERIAL

CEILING

LIGHTING

WALLS

PARTITIONS

FURNITURE

ADDITIONAL ITEMS

CREATE

ECHOMONOC® 12MM

Acoustic wall panels with bevelling. Installation by means of biodegradable EchoGlue® spray adhesive (included).

Absorption coefficient: α_w 0.30/0.60 (0mm/50mm wall distance)

Special dimensions and designs on request

You can always find the latest designs online at www.echojazz.com/echomonoc



NAME	ARTICLE	W x H x D (in mm)	UNIT	PET-BOTTLES
EchoMonoc® 12mm BALLOON LEFT	EM012BAL280120LE	1200x2800x12	1 pce	168
EchoMonoc® 12mm BALLOON RIGHT	EM012BAL280120RI	1200x2800x12	1 pce	168
EchoMonoc® 12mm CODE	EM012COD280120A	1200x2800x12	1 pce	168
EchoMonoc® 12mm DIAGONAL	EM012DIA280120A	1200x2800x12	1 pce	168
EchoMonoc® 12mm FENCE	EM012FEN280120A	1200x2800x12	1 pce	168
EchoMonoc® 12mm FISHBONE	EM012FIS280120A	1200x2800x12	1 pce	168
EchoMonoc® 12mm FLOW	EM012FLO280120A	1200x2800x12	1 pce	168
EchoMonoc® 12mm FRAGMENTS	EM012FRA280120A	1200x2800x12	1 pce	168
EchoMonoc® 12mm KINGSCROSS	EM012KIN280120A	1200x2800x12	1 pce	168
EchoMonoc® 12mm LEAVES	EM012LEA280120A	1200x2800x12	1 pce	168
EchoMonoc® 12mm SEAWEED	EM012SEA280120A	1200x2800x12	1 pce	168
EchoMonoc® 12mm SPHERE	EM012SPH280120A	1200x2800x12	1 pce	168
EchoMonoc® 12mm STREAMS	EM012STR280120A	1200x2800x12	1 pce	168
EchoMonoc® 12mm VERTIGO	EM012VER280120A	1200x2800x12	1 pce	168
EchoMonoc® 12mm WAVE	EM012WAV280120A	1200x2800x12	1 pce	168
EchoMonoc® 12mm ZIGZAG	EM012ZIG280120A	1200x2800x12	1 pce	168

ECHOMONOC® 12MM
BALLOON (LEFT/RIGHT)

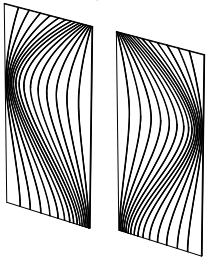

ECHOMONOC® 12MM
CODE

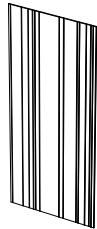

ECHOMONOC® 12MM
DIAGONAL

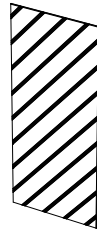

ECHOMONOC® 12MM
FENCE

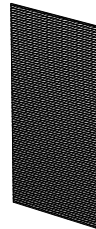

ECHOMONOC® 12MM
FISHBONE

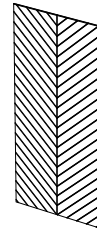

ECHOMONOC® 12MM
FLOW



ECHOMONOC® 12MM
FRAGMENTS



ECHOMONOC® 12MM
KINGSCROSS

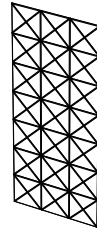

ECHOMONOC® 12MM
LEAVES



ECHOMONOC® 12MM
SEAWEED

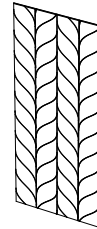

ECHOMONOC® 12MM
SPHERE



ECHOMONOC® 12MM
STREAMS

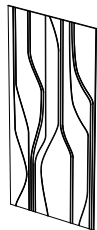

ECHOMONOC® 12MM
VERTIGO

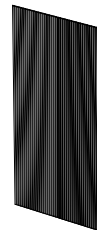

ECHOMONOC® 12MM
WAVE

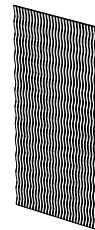

ECHOMONOC® 12MM
ZIGZAG



ECHOMONOC® 24MM

Acoustic wall panels with bevelling. Installation by means of biodegradable EchoGlue® spray adhesive (included).

Absorption coefficient: α_w 0.50/0.65 (0mm/50mm wall distance)

Special dimensions and designs on request

You can always find the latest designs online at www.echojazz.com/echomonoc



NAME	ARTICLE	W x H x D (in mm)	UNIT	PET-BOTTLES
EchoMonoc® 24mm BALLOON	EM024BAL238180A	1800x2380x24	1 pce	303
EchoMonoc® 24mm CODE	EM024COD238180A	1800x2380x24	1 pce	303
EchoMonoc® 24mm DIAGONAL	EM024DIA238180A	1800x2380x24	1 pce	303
EchoMonoc® 24mm FENCE	EM024FEN238180A	1800x2380x24	1 pce	303
EchoMonoc® 24mm FISHBONE	EM024FIS238180A	1770x2380x24	1 pce	303
EchoMonoc® 24mm FLOW	EM024FLO238180A	1770x2360x24	1 pce	303
EchoMonoc® 24mm FRAGMENTS	EM024FRA238180A	1800x2380x24	1 pce	303
EchoMonoc® 24mm KINGSCROSS	EM024KIN238180A	1770x2360x24	1 pce	303
EchoMonoc® 24mm LEAVES	EM024LEA238180A	1800x2380x24	1 pce	303
EchoMonoc® 24mm SEAWEED	EM024SEA238180A	1800x2380x24	1 pce	303
EchoMonoc® 24mm SPHERE	EM024SPH238180A	1800x2380x24	1 pce	303
EchoMonoc® 24mm STREAMS	EM024STR238180A	1800x2380x24	1 pce	303
EchoMonoc® 24mm VERTIGO	EM024VER238180A	1800x2380x24	1 pce	303
EchoMonoc® 24mm WAVE	EM024WAV238180A	1800x2380x24	1 pce	303
EchoMonoc® 24mm ZIGZAG	EM024ZIG238180A	1800x2380x24	1 pce	303

ECHOMONOC® 24MM
BALLOON

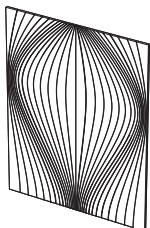

ECHOMONOC® 24MM
CODE

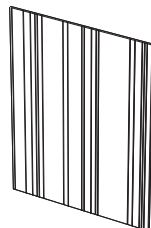

ECHOMONOC® 24MM
DIAGONAL

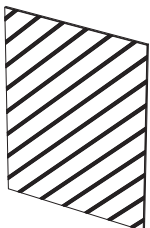

ECHOMONOC® 24MM
FENCE

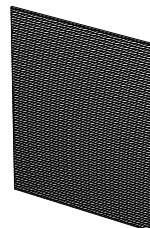

ECHOMONOC® 24MM
FISHBONE

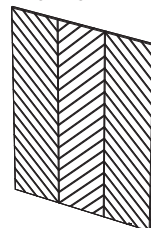

ECHOMONOC® 24MM
FLOW

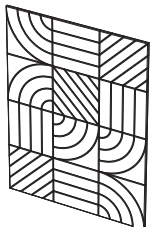

ECHOMONOC® 24MM
FRAGMENTS

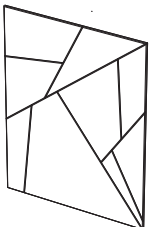

ECHOMONOC® 24MM
KINGSCROSS

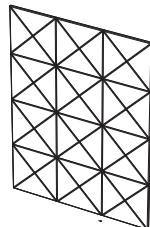

ECHOMONOC® 24MM
LEAVES



ECHOMONOC® 24MM
SEAWEED

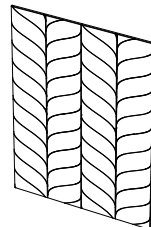

ECHOMONOC® 24MM
SPHERE

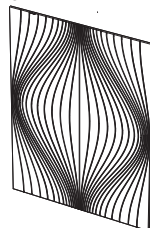

ECHOMONOC® 24MM
STREAMS

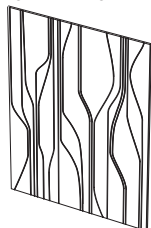

ECHOMONOC® 24MM
VERTIGO

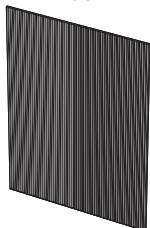

ECHOMONOC® 24MM
WAVE

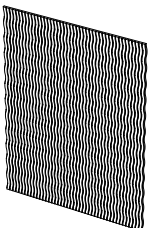

ECHOMONOC® 24MM
ZIGZAG

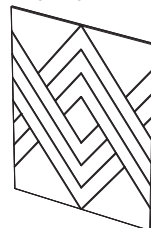

ECHOCOUSTIC® ACCENT

EchoCoustic® with V-shaped cuts makes the white high-performance absorption layer visible. This creates special line designs and thus accentuates in the truest sense of the word. The special EchoCoustic® absorber is the ideal material for direct application to walls or ceilings without spacing or substructure. With its three layers, it achieves an excellent absorption coefficient of α_w 0.80 and NRC 0.85 with a thickness of only 25mm. The absorber made of recycled PET is extremely robust and suitable for regular cleaning and disinfection. Installation is quick and easy with EchoGlue® contact spray adhesive.

The design of large-area acoustic walls takes on a new dimension. The high-contrast recesses allow for spectacular patterns, from existing designs to completely customised creations.





COMPANY PROFILE

MATERIAL

CEILING

LIGHTING

WALLS

PARTITIONS

FURNITURE

ADDITIONAL ITEMS

CREATE

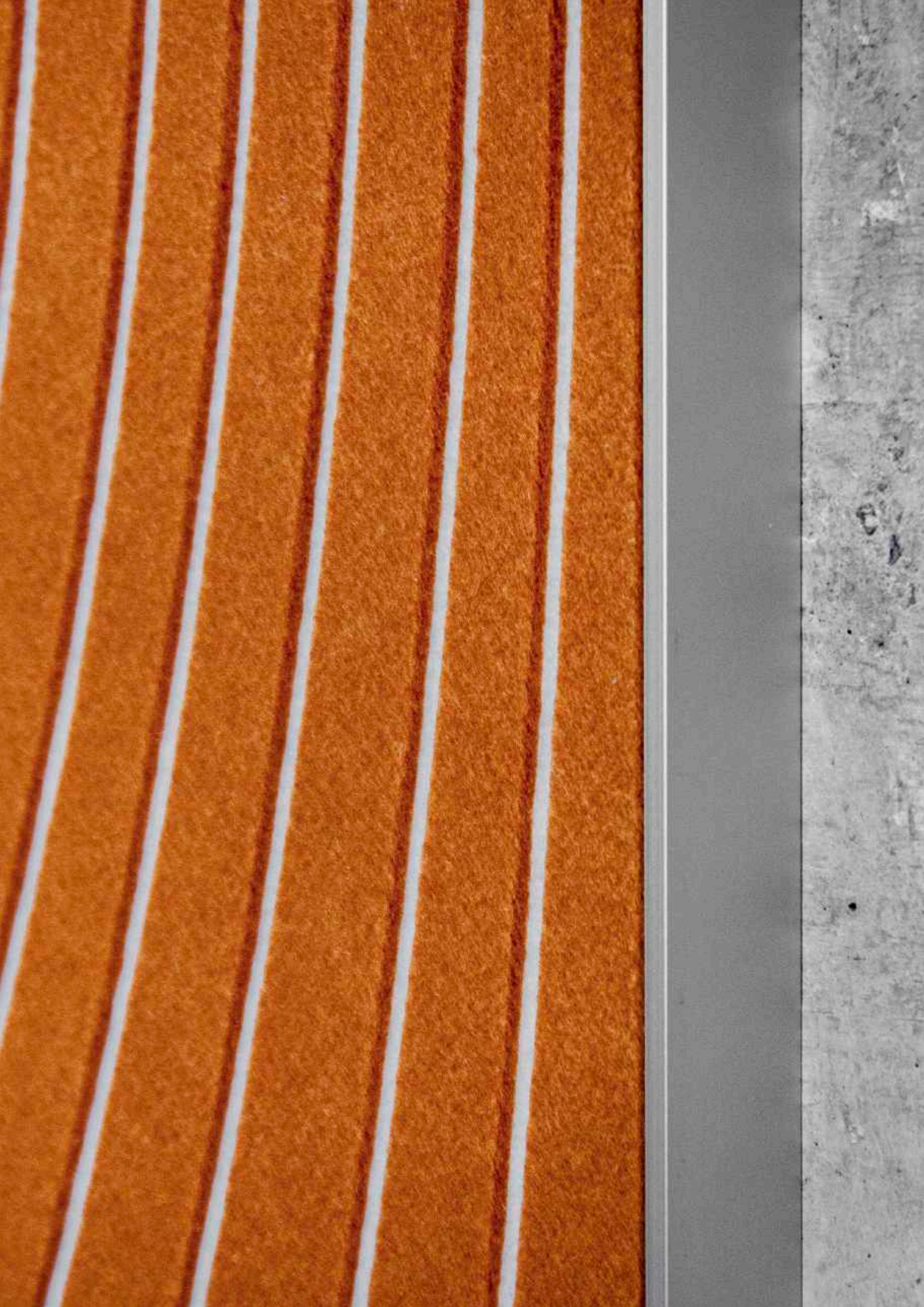

ECHOCOUSTIC® 25MM ACCENT

Acoustic wall panels with bevelling. Installation by means of biodegradable EchoGlue® spray adhesive (included).

Absorption coefficient: α_w 0.80, class B

You can always find the latest designs online at www.echojazz.com/echocoustic-accent

Discover our EchoCoustic® 25mm PROFILE edge profiles! (Page 167)



NAME	ARTICLE	W x H x D (in mm)	UNIT	PET-BOTTLES
EchoCoustic® 25mm ACCENT BALLON LEFT	EAC25BAL270119LE	1190x2700x25	1 Pce	177
EchoCoustic® 25mm ACCENT BALLON RIGHT	EAC25BAL270119RI	1190x2700x25	1 Pce	177
EchoCoustic® 25mm ACCENT CODE	EAC25COD270119A	1190x2700x25	1 Pce	177
EchoCoustic® 25mm ACCENT DIAGONAL	EAC25DIA270119A	1190x2700x25	1 Pce	177
EchoCoustic® 25mm ACCENT FENCE	EAC25FEN270119A	1190x2700x25	1 Pce	177
EchoCoustic® 25mm ACCENT SPHERE	EAC25SPH270119A	1190x2700x25	1 Pce	177
EchoCoustic® 25mm ACCENT STREAMS	EAC25STR270119A	1190x2700x25	1 Pce	177
EchoCoustic® 25mm ACCENT VERTIGO	EAC25VER270119A	1190x2700x25	1 Pce	177
EchoCoustic® 25mm ACCENT WAVE	EAC25WAV270119A	1190x2700x25	1 Pce	177

ECHOCOUSTIC® 25MM ACCENT
BALLOON (LEFT/RIGHT)

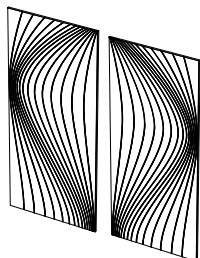

ECHOCOUSTIC® 25MM ACCENT
CODE

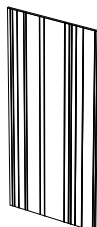

ECHOCOUSTIC® 25MM ACCENT
DIAGONAL



ECHOCOUSTIC® 25MM ACCENT
FENCE



ECHOCOUSTIC® 25MM ACCENT
SPHERE

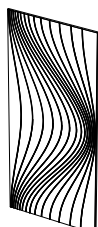

ECHOCOUSTIC® 25MM ACCENT
STREAMS



ECHOCOUSTIC® 25MM ACCENT
VERTIGO

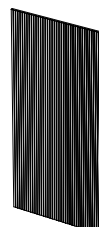

ECHOCOUSTIC® 25MM ACCENT
WAVE

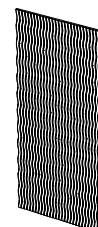



ACOUSTIC-PARTITIONS

Partition walls with sound insulation make it easy to divide rooms and optimise room acoustics in offices as well as in all other living and working environments. Available as mobile or permanently installed elements, they offer countless possibilities for room design.



ECHOCURTAIN®

As an acoustic room divider in an open-space office, the EchoCurtain® in 12mm and 24mm material thicknesses offers a flexible and transparent solution. The EchoCurtain® is suspended directly from the ceiling by means of a steel cable suspension, or optionally with a rail system. The acoustic room divider hangs seemingly floating in the room and provides a specific touch with cut-out perforations.

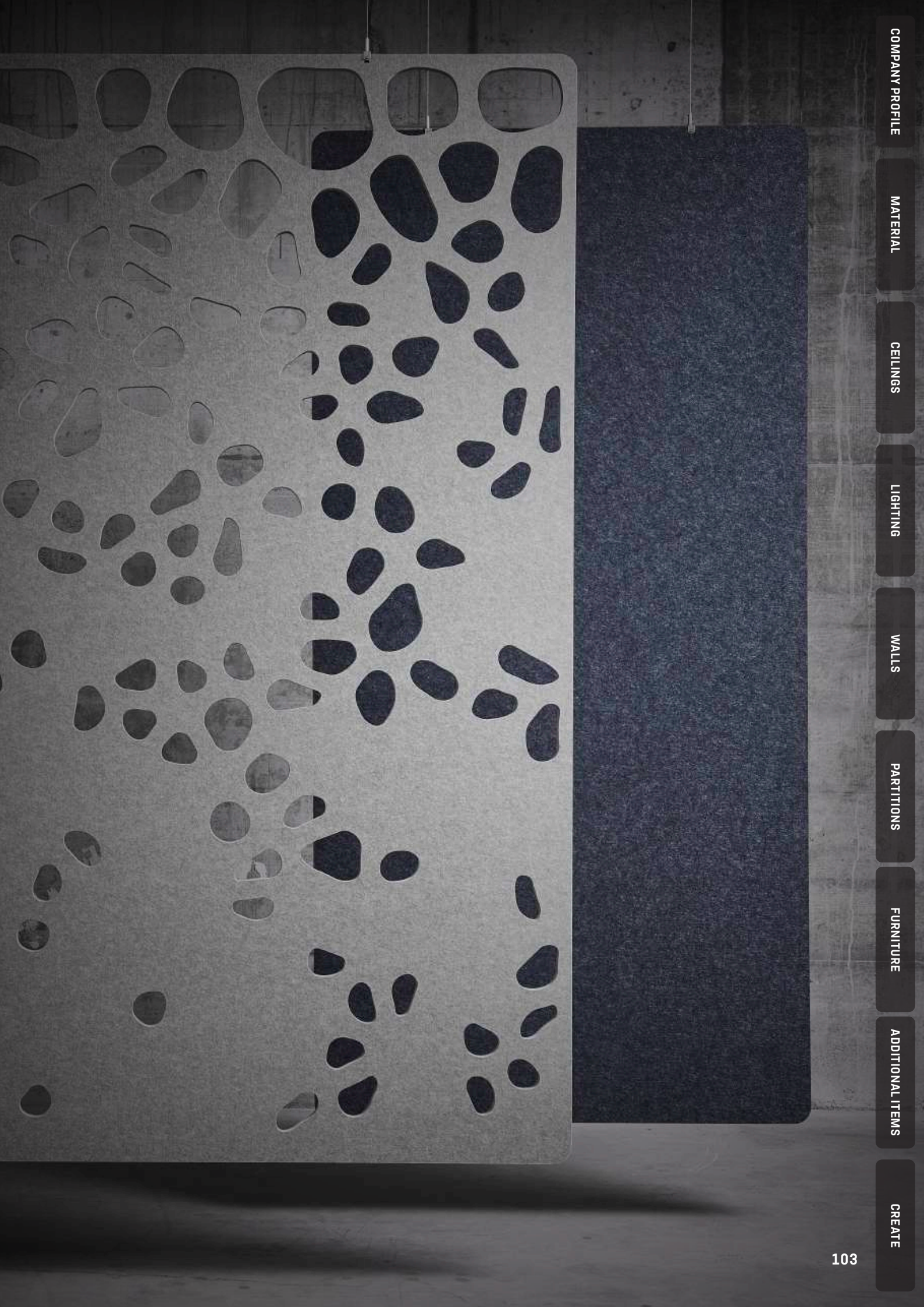

COMPANY PROFILE

MATERIAL

CEILING

LIGHTING

WALLS

PARTITIONS

FURNITURE

ADDITIONAL ITEMS

CREATE

ECHOCURTAIN® 12MM

Suspended acoustic screens incl. suspension system

Absorption coefficient: α_w 0.90, class A

Special dimensions and designs on request

This product is available with our perforations. ([Page 189](#))



NAME	ARTICLE	W x H x D (in mm)	UNIT	PET-BOTTLES
EchoCurtain® 12mm PLAIN	ECU12ECU120280A	1200x2800x12	1 pce	168

ECHOCURTAIN® 12MM
PLAIN



ECHOCURTAIN® 24MM

Suspended acoustic screens incl. suspension system

Absorption coefficient: α_w 1.00, class A

Special dimensions and designs on request

This product is available with our perforations. ([Page 189](#))



NAME	ARTICLE	W x H x D (in mm)	UNIT	PET-BOTTLES
EchoCurtain® 24mm PLAIN	ECU24ECU180238A	1800x2380x24	1 pce	303

ECHOCURTAIN® 24MM
PLAIN

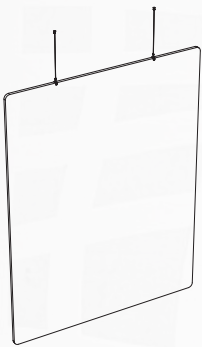



ECHOTORRENT®

The EchoTorrent® acoustic partitions were specially developed for high rooms with a ceiling height of up to four metres, whereby the high-performance acoustic absorbers can be positioned at individual heights. The clamping elements are firmly screwed to the ceiling and floor. The acoustic elements are clamped to the connecting cables.



COMPANY PROFILE

MATERIAL

CEILING

LIGHTING

WALLS

PARTITIONS

FURNITURE

ADDITIONAL ITEMS

CREATE

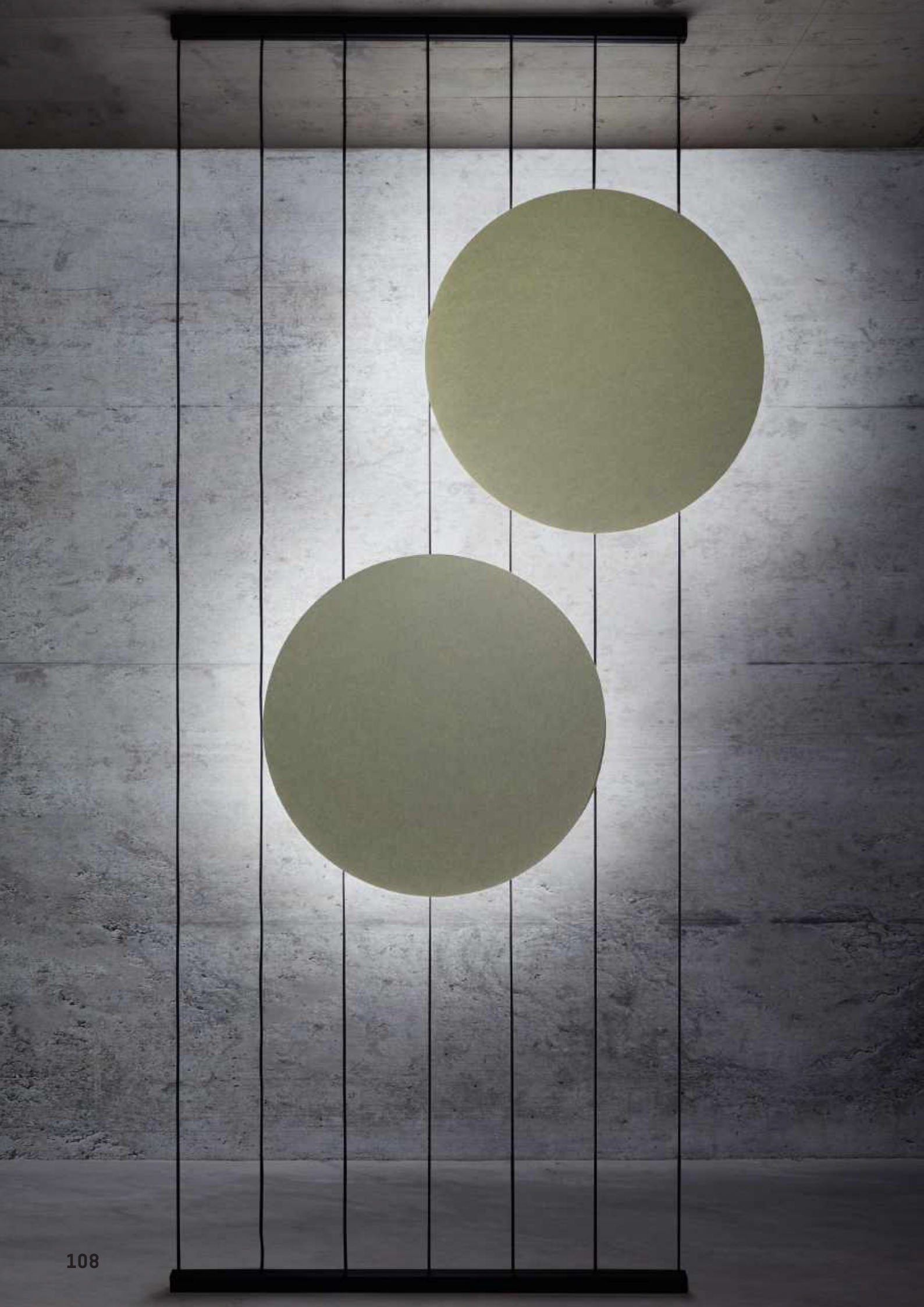

ECHOTORRENT® 24MM

Hanging acoustic screens incl. suspension system

Absorption coefficient: [aw 1.00, class A](#)

[Special dimensions and designs on request](#)

NAME	ARTICLE	W x H x D (in mm)	UNIT	PET-BOTTLES
EchoTorrent® 24mm DOT DOUBLE	ET024DOT078078B	1180x4000x34 / Ø780	1 pce	208

ECHOTORRENT® 24MM
DOT DOUBLE

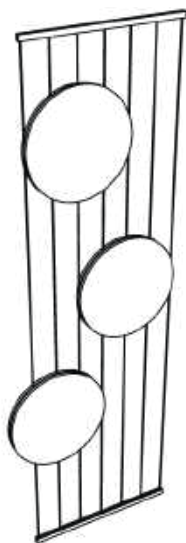

COMPANY PROFILE

MATERIAL

CEILING

LIGHTING

WALLS

PARTITIONS

FURNITURE

ADDITIONAL ITEMS

CREATE



ECHOCOVE® ECO

Thanks to a plug-in system, the EchoCove® ECO and PALING movable walls offer endless combination possibilities. They can be assembled and reconfigured without tools. The high density of the lightweight material of these acoustic partitions allows for a frameless construction. The perforations create the desired degree of permeability and attention with sophisticated details.

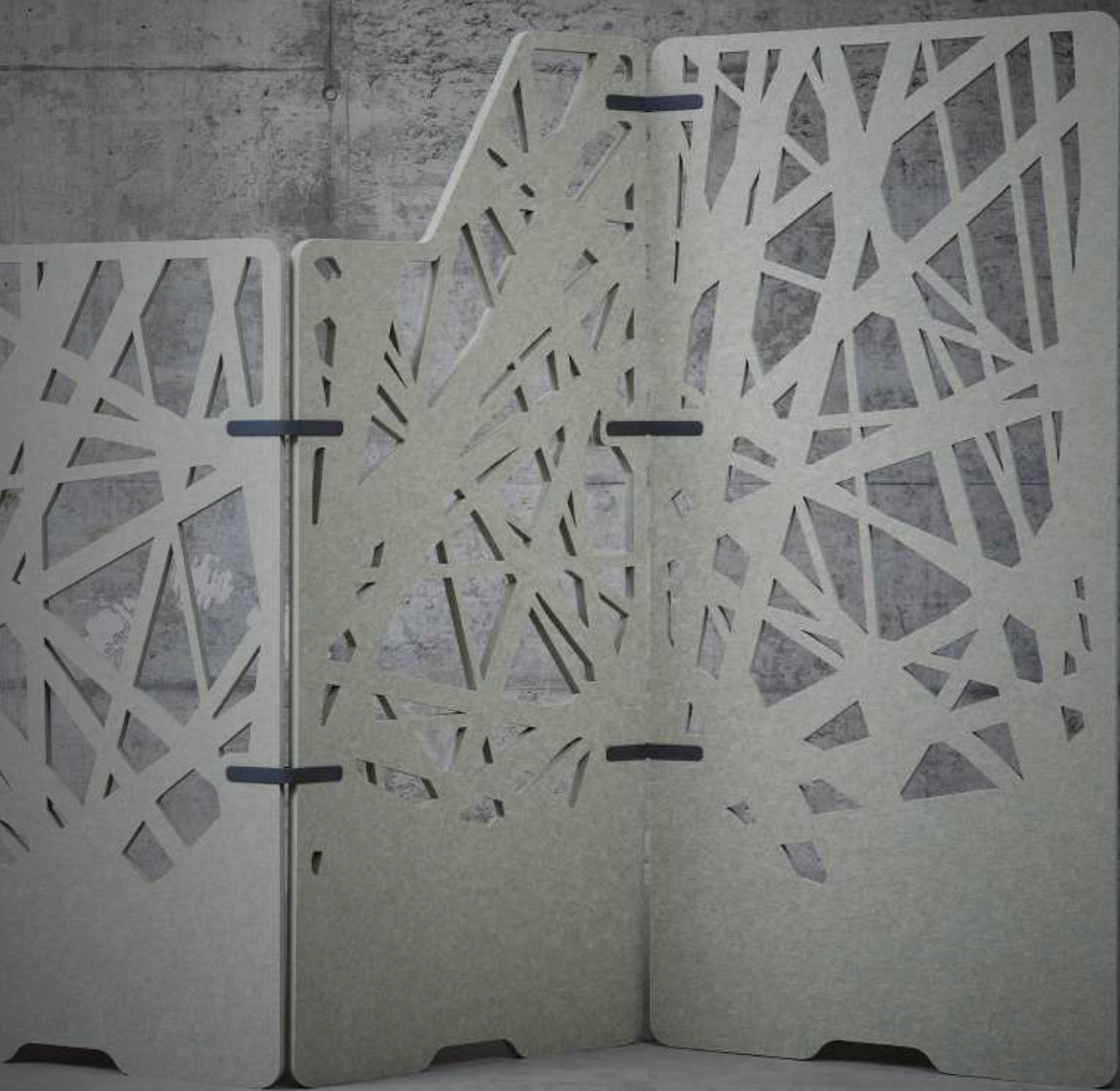



ECHOCOVE® 24MM ECO 79

Frameless acoustic partition for installation on the floor (tool-free) excl. EchoCove® JOINER connectors.

Absorption coefficient: α_w 1.00, class A

Special dimensions and designs on request.

Please specify the joiner type when ordering. (Page 173)

This product is available with our perforations. (Page 189)

NAME	ARTICLE	W x H x D (in mm)	UNIT	PET-BOTTLES
EchoCove® 24mm ECO END 79 S	ECO24END079118A	790x1180x24	1 pce	68
EchoCove® 24mm ECO END 79 M	ECO24END079142A	790x1420x24	1 pce	79
EchoCove® 24mm ECO END 79 L	ECO24END079180A	790x1800x24	1 pce	101
EchoCove® 24mm ECO STEP END 79 M	ECO24STE079142A	790x1420x24	1 pce	79
EchoCove® 24mm ECO STEP END 79 L	ECO24STE079180A	790x1800x24	1 pce	101
EchoCove® 24mm ECO MID 79 S	ECO24MID079118A	790x1180x24	1 pce	68
EchoCove® 24mm ECO MID 79 M	ECO24MID079142A	790x1420x24	1 pce	79
EchoCove® 24mm ECO MID 79 L	ECO24MID079180A	790x1800x24	1 pce	101
EchoCove® 24mm ECO STEP MID 79 M	ECO24STM079142A	790x1420x24	1 pce	79
EchoCove® 24mm ECO STEP MID 79 L	ECO24STM079180A	790x1800x24	1 pce	101

ECHOCOVE® 24MM ECO
END 79 S

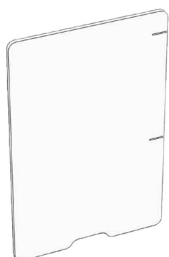

ECHOCOVE® 24MM ECO
END 79 M

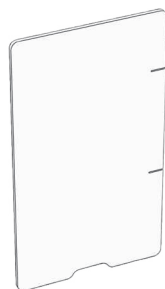

ECHOCOVE® 24MM ECO
END 79 L



ECHOCOVE® 24MM ECO
STEP END 79 M

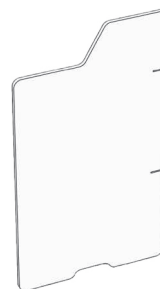

ECHOCOVE® 24MM ECO
STEP END 79 L

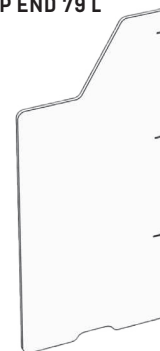

ECHOCOVE® 24MM ECO
MID 79 S

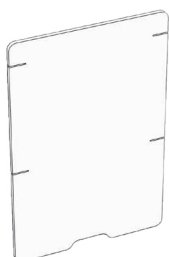

ECHOCOVE® 24MM ECO
MID 79 M

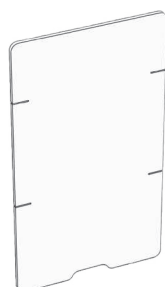

ECHOCOVE® 24MM ECO
MID 79 L



ECHOCOVE® 24MM ECO
STEP MID 79 M

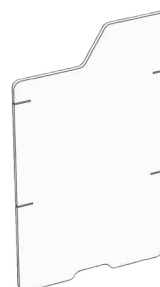

ECHOCOVE® 24MM ECO
STEP MID 79 L

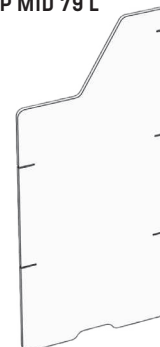

ECHOCOVE® 24MM ECO 159

Frameless acoustic partition for installation on the floor (tool-free) excl. EchoCove® JOINER connectors.

Absorption coefficient: α_w 1.00, class A

Special dimensions and designs on request.

Please specify the joiner type when ordering. [\(Page 173\)](#)

This product is available with our perforations. [\(Page 189\)](#)

NAME	ARTICLE	W x H x D (in mm)	UNIT	PET-BOTTLES
EchoCove® 24mm ECO MID 159 S	EC024MID159118A	1585x1180x24	1 pce	137
EchoCove® 24mm ECO MID 159 M	EC024MID159142A	1585x1420x24	1 pce	159
EchoCove® 24mm ECO MID 159 L	EC024MID159180A	1585x1800x24	1 pce	202

ECHOCOVE® 24MM ECO
MID 159 S

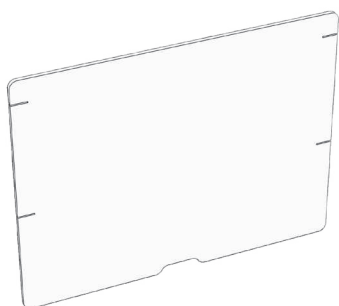

ECHOCOVE® 24MM ECO
MID 159 M

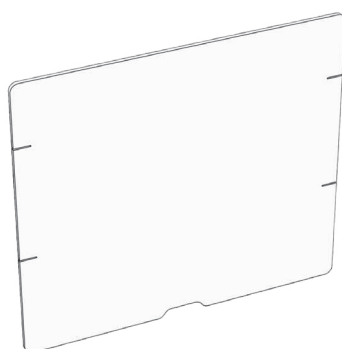

ECHOCOVE® 24MM ECO
MID 159 L

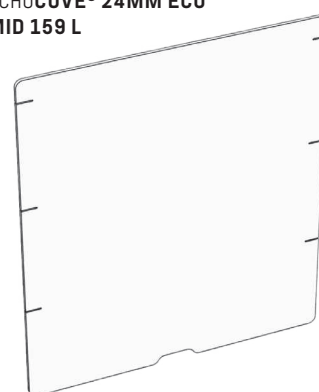

ECHOCOVE® 24MM ECO 180

Frameless acoustic partition for installation on the floor (tool-free) excl. EchoCove® JOINER connectors.

Absorption coefficient: α_w 1.00, class A

Special dimensions and designs on request.

Please specify the joiner type when ordering. ([Page 173](#))

This product is available with our perforations. ([Page 189](#))

NAME	ARTICLE	W x H x D (in mm)	UNIT	PET-BOTTLES
EchoCove® 24mm ECO MID 180 S	ECO24MID180118A	1800x1180x24	1 pce	156
EchoCove® 24mm ECO MID 180 M	ECO24MID180142A	1800x1420x24	1 pce	181
EchoCove® 24mm ECO MID 180 L	ECO24MID180180A	1800x1800x24	1 pce	230

ECHOCOVE® 24MM ECO
MID 180 S



ECHOCOVE® 24MM ECO
MID 180 M

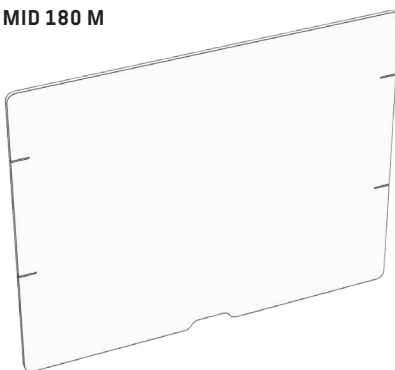

ECHOCOVE® 24MM ECO
MID 180 L

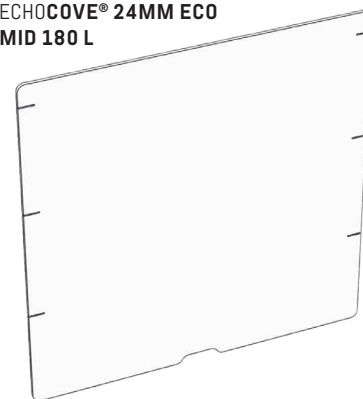



ECHOCOVE® PALING

Thanks to a plug-in system, the EchoCove® ECO and PALING movable walls offer endless combination possibilities. They can be assembled and reconfigured without tools. The high density of the lightweight material of these acoustic partitions allows for a frameless construction. The perforations create the desired degree of permeability and attention with sophisticated details.

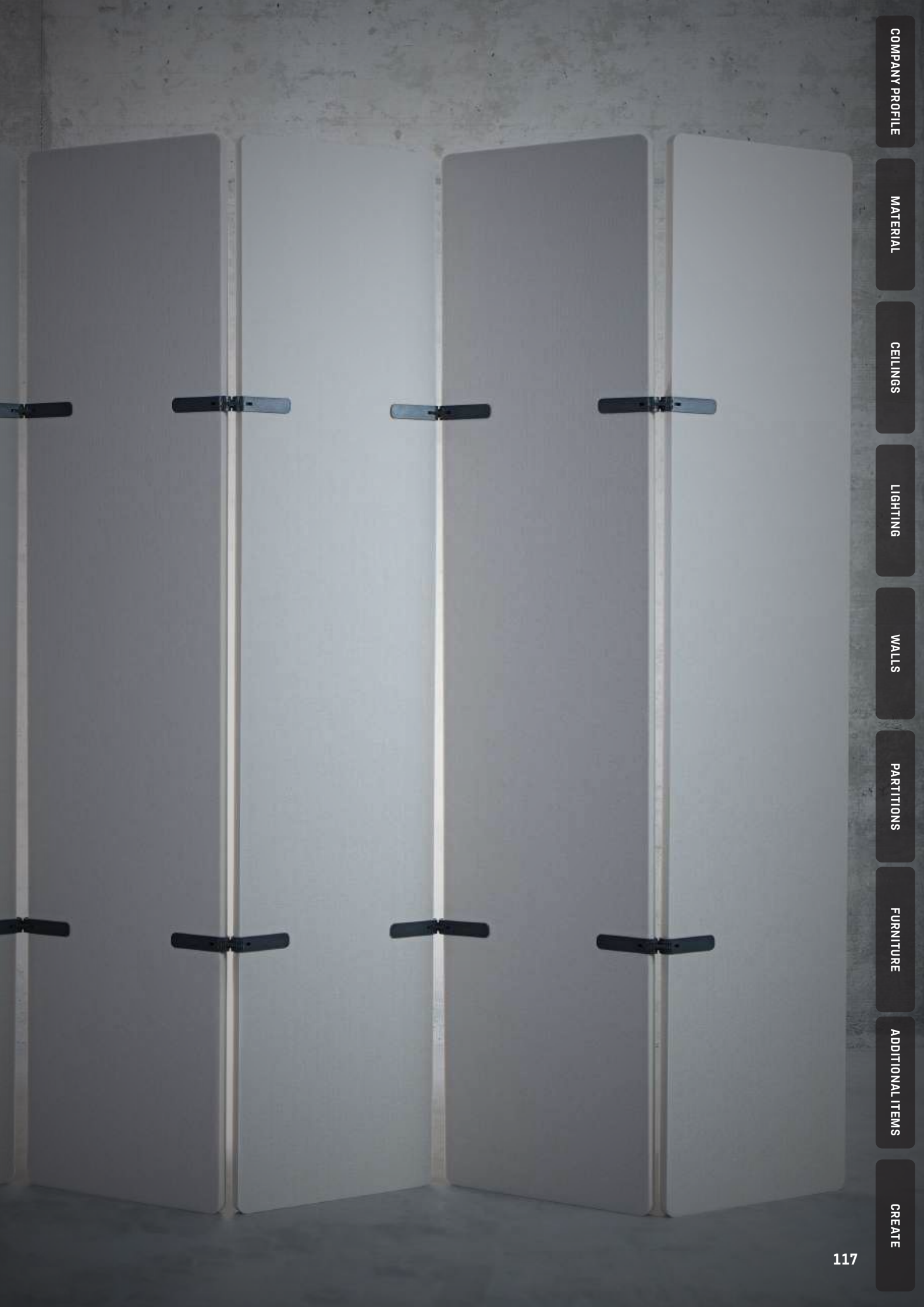

COMPANY PROFILE

MATERIAL

CEILING

LIGHTING

WALLS

PARTITIONS

FURNITURE

ADDITIONAL ITEMS

CREATE

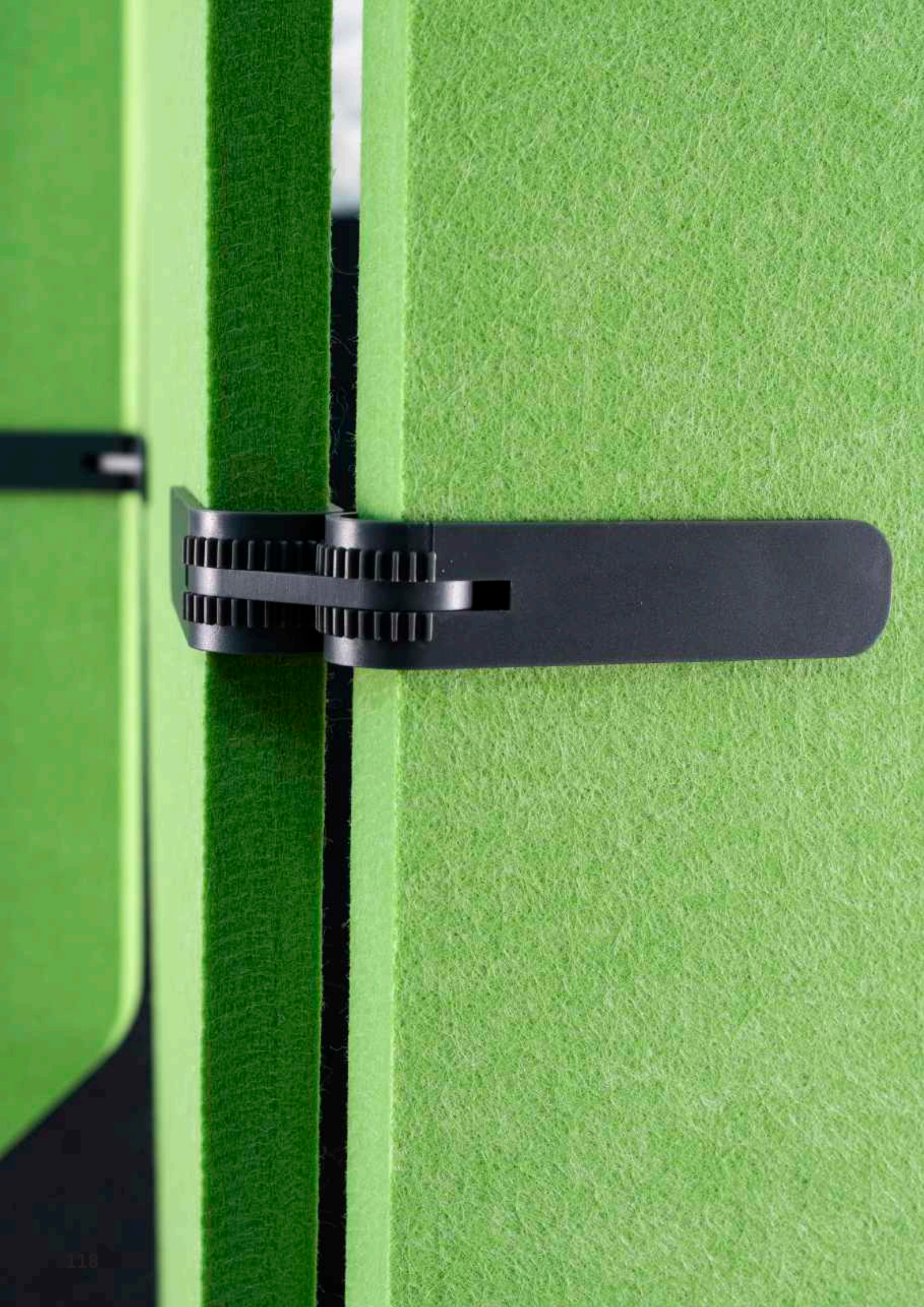

ECHOCOVE® 24MM PALING

Frameless folding acoustic wall incl. EchoCove® JOINER PIVOT.

Absorption coefficient: α_w 1.00, class A

Special dimensions and designs on request

This product is available with our perforations. ([Page 189](#))

NAME	ARTICLE	W x H x D (in mm)	UNIT	PET-BOTTLES
EchoCove® 24mm PALING	EC024PAL039180A	2125x1800x230	1 set	297

ECHOCOVE® 24MM
PALING

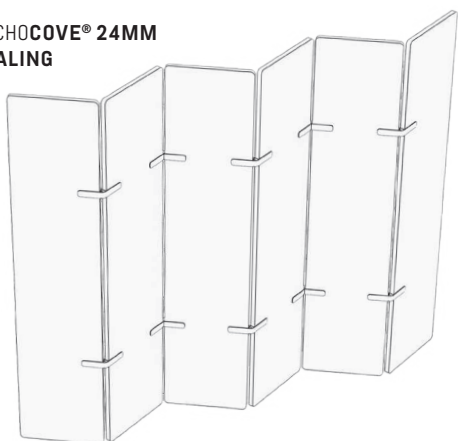



ECHOCOVE® STAND

EchoCove® STAND offers a free-standing, frameless solution as a room divider or workstation partition. The panel is offered in four heights and two widths with maximum dimensions of 180cm by 180cm. The high-quality steel base ensures a secure stand. Assembly is tool-free.



COMPANY PROFILE

MATERIAL

CEILING

LIGHTING

WALLS

PARTITIONS

FURNITURE

ADDITIONAL ITEMS

CREATE

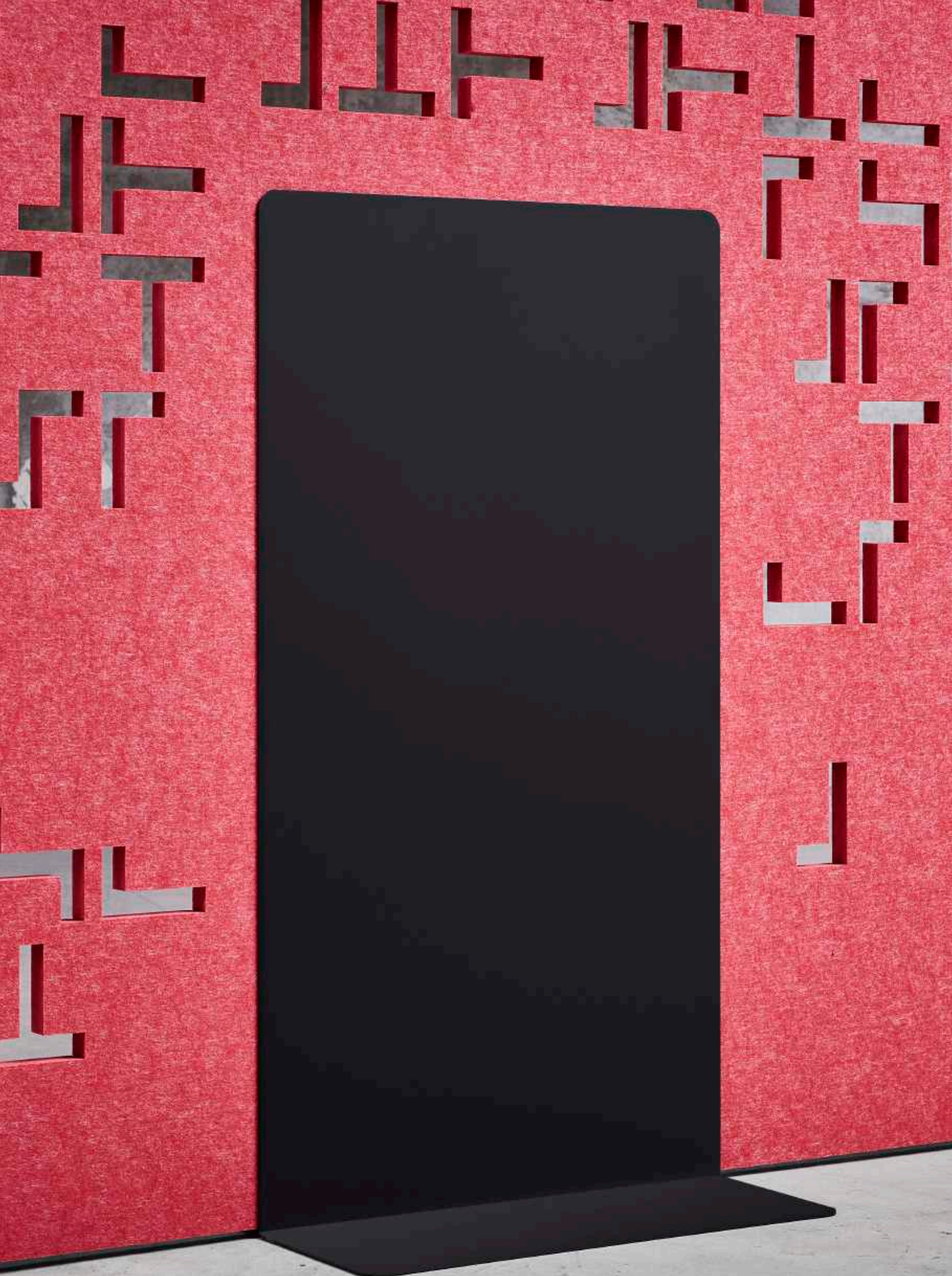

ECHOCOVE® 24MM STAND

Frameless acoustic partition wall for installation on the floor, team tables or storage furniture incl. high-quality base, deep matt powder-coated (no tools required).

Absorption coefficient: α_w 1.00, class A

Colour of base: Black RAL9005

From an order quantity of 10 pieces, the foot is available in all RAL colours for a surcharge of 5%.

This product is available with our perforations. ([Page 189](#))

NAME	ARTICLE	W x H x D (in mm)	UNIT	PET-BOTTLES
EchoCove® 24mm STAND 160 S	EC024STA160059A	1600x590x200	1 set	67
EchoCove® 24mm STAND 160 M	EC024STA160118A	1600x1180x400	1 set	138
EchoCove® 24mm STAND 160 L	EC024STA160142A	1600x1420x400	1 set	161
EchoCove® 24mm STAND 160 XL	EC024STA160180A	1600x1800x400	1 set	204
EchoCove® 24mm STAND 180 S	EC024STA180059A	1800x590x200	1 set	75
EchoCove® 24mm STAND 180 M	EC024STA180118A	1800x1180x400	1 set	156
EchoCove® 24mm STAND 180 L	EC024STA180142A	1800x1420x400	1 set	181
EchoCove® 24mm STAND 180 XL	EC024STA180180A	1800x1800x400	1 set	230

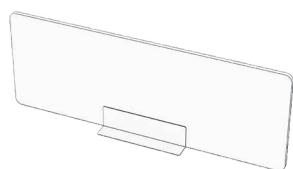

**ECHOCOVE® 24MM STAND
160 S**

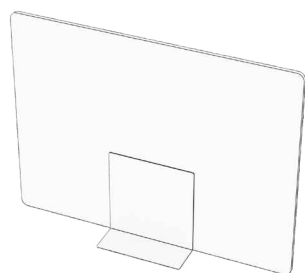

**ECHOCOVE® 24MM STAND
160 M**

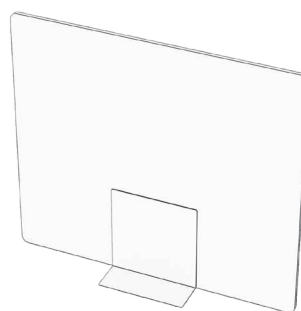

**ECHOCOVE® 24MM STAND
160 L**

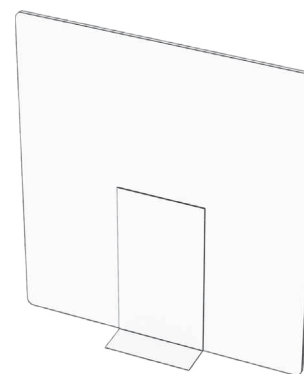

**ECHOCOVE® 24MM STAND
160 XL**

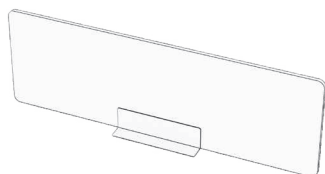

**ECHOCOVE® 24MM STAND
180 S**

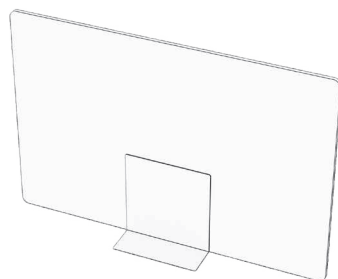

**ECHOCOVE® 24MM STAND
180 M**

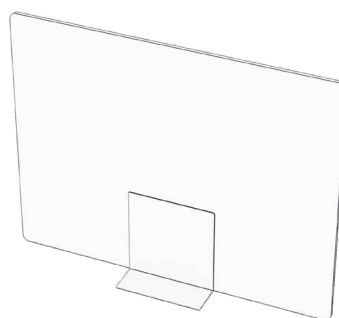

**ECHOCOVE® 24MM STAND
180 L**

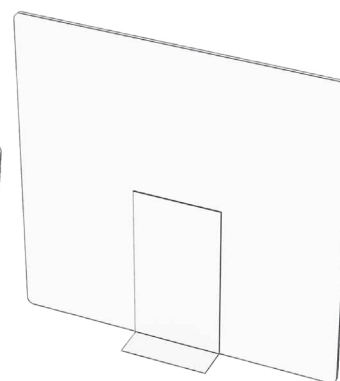

**ECHOCOVE® 24MM STAND
180 XL**



ECHOCOVE® MOVE

Movable partitions allow open-plan offices to be temporarily separated and acoustically insulated. The lightweight EchoCove® MOVE solution offers a wide range of products that come in sizes up to 180cm x 180cm and in many colours. Thanks to the high-quality steel base and the castors with stoppers, the acoustic panels can be easily moved around the room and safely parked.

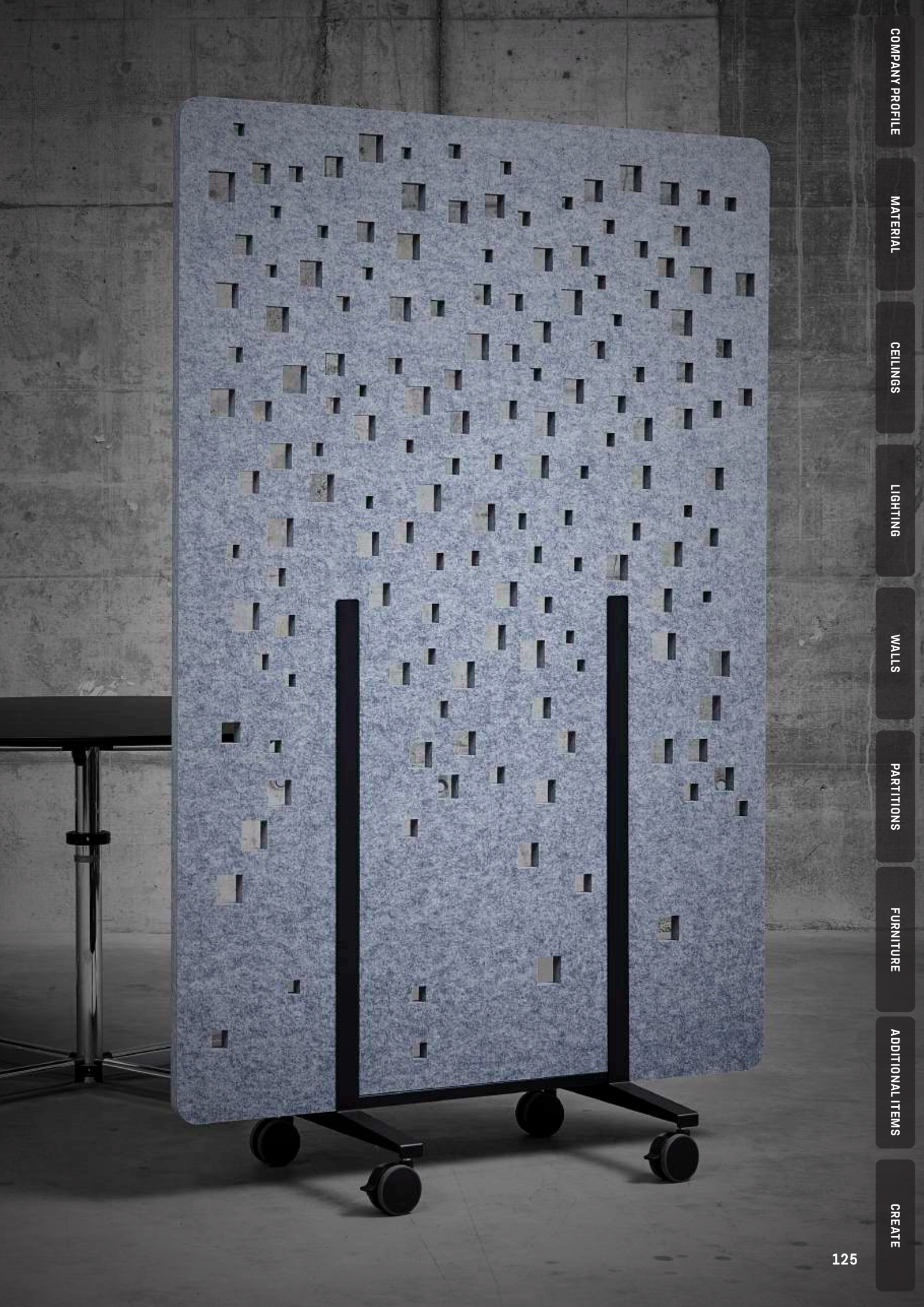

COMPANY PROFILE

MATERIAL

CEILING

LIGHTING

WALLS

PARTITIONS

FURNITURE

ADDITIONAL ITEMS

CREATE

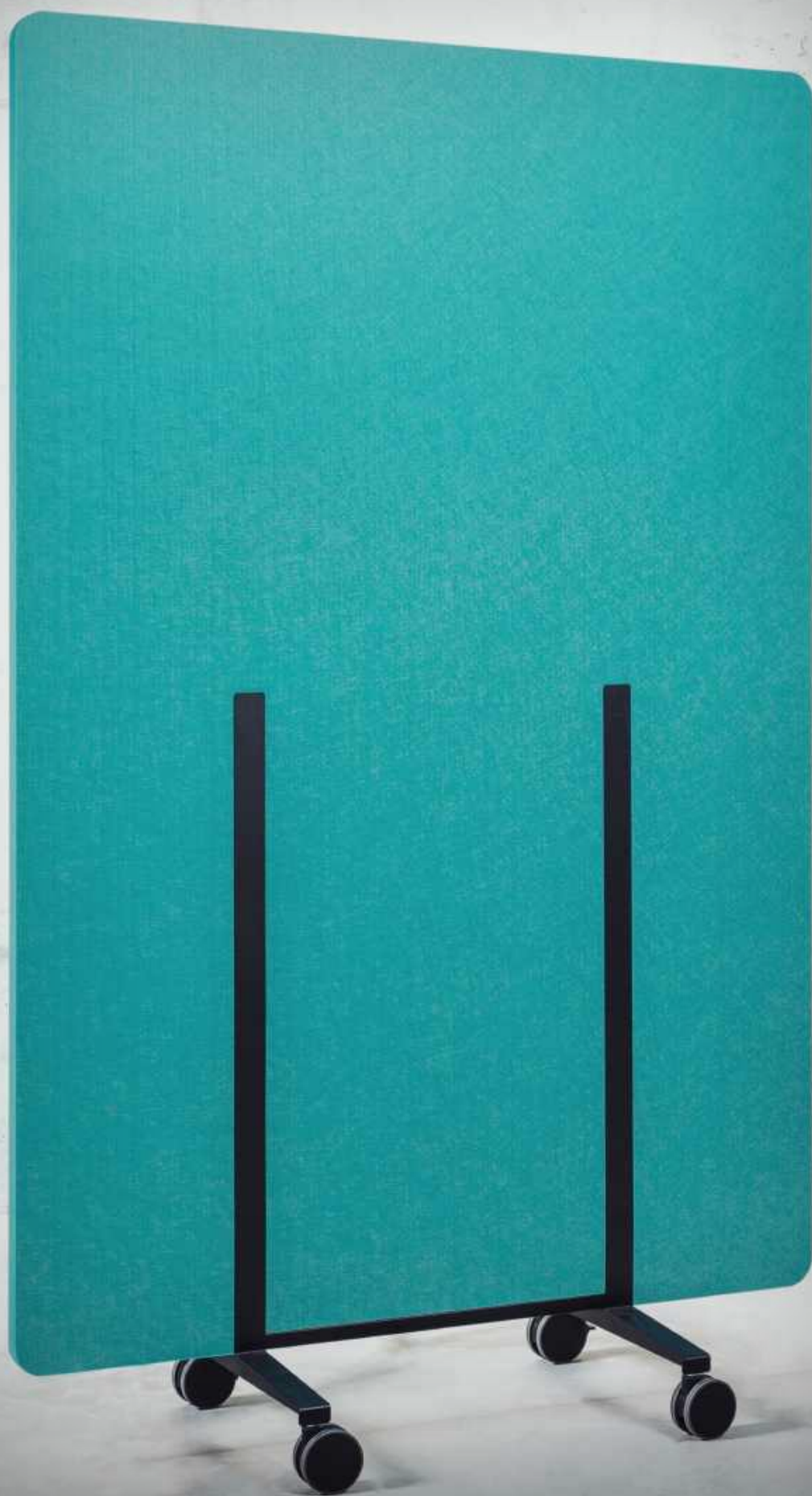

ECHOCOVE® 24MM MOVE

Frameless acoustic movable wall with high-quality base frame with castors incl. stoppers, deep matt powder-coated (no tools required).

Absorption coefficient: α_w 1.00, class A

Colour of base: Black RAL9005

From an order quantity of 10 pieces, the foot is available in all RAL colours at a surcharge of 5%.

This product is available with our perforations. ([Page 189](#))

NAME	ARTICLE	W x H x D (in mm)	UNIT	PET-BOTTLES
EchoCove® 24mm MOVE LOW S	EC024MOV118142A	1180x1420x430	1 set	119
EchoCove® 24mm MOVE LOW M	EC024MOV160142A	1600x1420x430	1 set	161
EchoCove® 24mm MOVE LOW L	EC024MOV180142A	1800x1420x430	1 set	181
EchoCove® 24mm MOVE HIGH S	EC024MOV118180A	1180x1800x430	1 set	150
EchoCove® 24mm MOVE HIGH M	EC024MOV160180A	1600x1800x430	1 set	204
EchoCove® 24mm MOVE HIGH L	EC024MOV180180A	1800x1800x430	1 set	230

**ECHOCOVE® 24MM MOVE
LOW S**

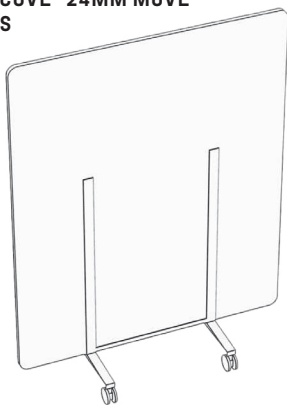

**ECHOCOVE® 24MM MOVE
LOW M**

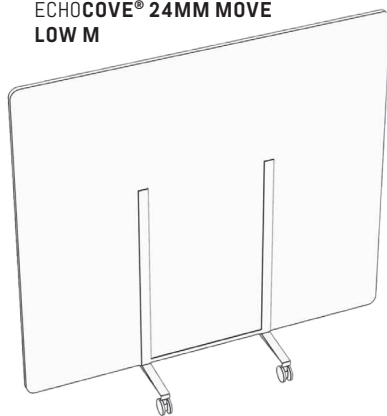

**ECHOCOVE® 24MM MOVE
LOW L**

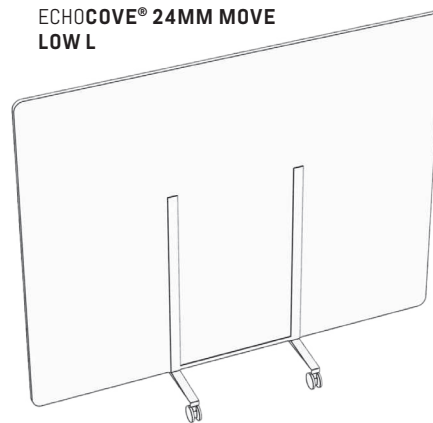

**ECHOCOVE® 24MM MOVE
HIGH S**

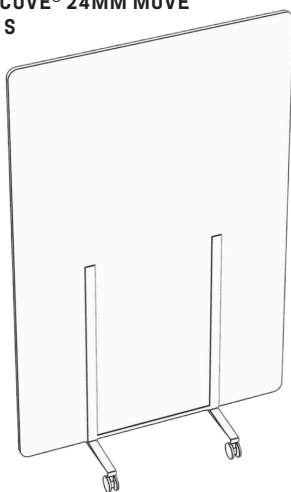

**ECHOCOVE® 24MM MOVE
HIGH M**

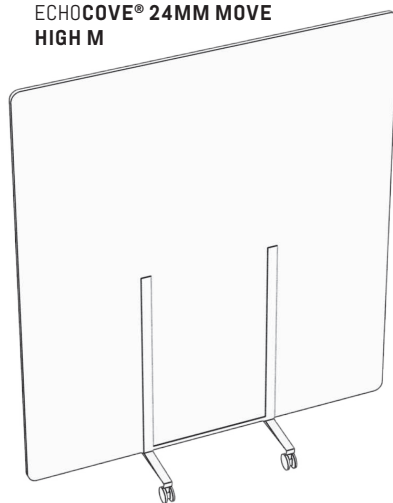

**ECHOCOVE® 24MM MOVE
HIGH L**

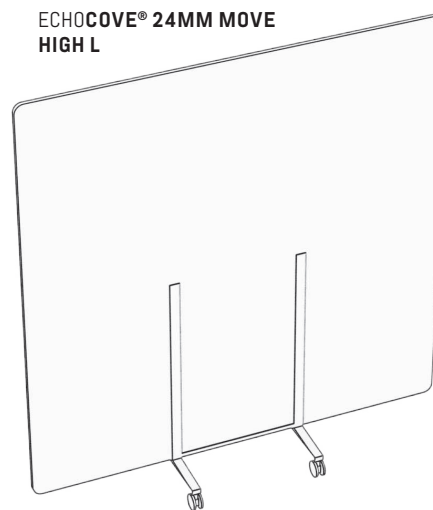



ECHOCOVE® DESK

EchoCove® DESK separates workstations visually and acoustically. The standard adapters allow mounting on table tops from 16mm to 75mm thickness. Installation is quick and easy.



COMPANY PROFILE

MATERIAL

CEILING

LIGHTING

WALLS

PARTITIONS

FURNITURE

ADDITIONAL ITEMS

CREATE



ECHOCOVE® 24MM DESK ONE

Frameless acoustic wall incl. high-quality table adapter, deep matt powder-coated.

Absorption coefficient: α_w 1.00, class A

Please specify the table adapter type when ordering. (Page 175)

This product is available with our perforations. (Page 189)

NAME	ARTICLE	W x H x D (in mm)	UNIT	PET-BOTTLES
EchoCove® 24mm DESK ONE 470 S	EC024DE1118047A	1180x470x24	1 pce	39
EchoCove® 24mm DESK ONE 470 M	EC024DE1140047A	1400x470x24	1 pce	47
EchoCove® 24mm DESK ONE 470 L	EC024DE1160047A	1600x470x24	1 pce	53
EchoCove® 24mm DESK ONE 470 XL	EC024DE1180047A	1800x470x24	1 pce	60
EchoCove® 24mm DESK ONE 590 S	EC024DE1118059A	1180x590x24	1 pce	49
EchoCove® 24mm DESK ONE 590 M	EC024DE1140059A	1400x590x24	1 pce	59
EchoCove® 24mm DESK ONE 590 L	EC024DE1160059A	1600x590x24	1 pce	67
EchoCove® 24mm DESK ONE 590 XL	EC024DE1180059A	1800x590x24	1 pce	75

**ECHOCOVE® 24MM
DESK ONE 470 S**



**ECHOCOVE® 24MM
DESK ONE 470 M**



**ECHOCOVE® 24MM
DESK ONE 470 L**



**ECHOCOVE® 24MM
DESK ONE 470 XL**



**ECHOCOVE® 24MM
DESK ONE 590 S**



**ECHOCOVE® 24MM
DESK ONE 590 M**

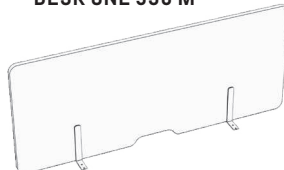

**ECHOCOVE® 24MM
DESK ONE 590 L**

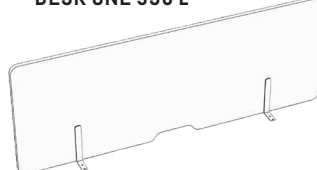

**ECHOCOVE® 24MM
DESK ONE 590 XL**





ECHOCOVE® 24MM DESK TWO

Frameless acoustic wall with 300mm privacy screen under the tabletop incl. high-quality table adapter, deep matt powder-coated.

Absorption coefficient: α_w 1.00, class A

Please specify the table adapter type when ordering. (Page 175)

This product is available with our perforations. (Page 189)

NAME	ARTICLE	W x H x D (in mm)	UNIT	PET-BOTTLES
EchoCove® 24mm DESK TWO 470 XS	EC024DE2079077A	790x770x24	1 pce	43
EchoCove® 24mm DESK TWO 470 S	EC024DE2118077A	1180x770x24	1 pce	64
EchoCove® 24mm DESK TWO 470 M	EC024DE2140077A	1400x770x24	1 pce	76
EchoCove® 24mm DESK TWO 470 L	EC024DE2160077A	1600x770x24	1 pce	87
EchoCove® 24mm DESK TWO 470 XL	EC024DE2180077A	1800x770x24	1 pce	98
EchoCove® 24mm DESK TWO 590 XS	EC024DE2079089A	790x890x24	1 pce	50
EchoCove® 24mm DESK TWO 590 S	EC024DE2118089A	1180x890x24	1 pce	74
EchoCove® 24mm DESK TWO 590 M	EC024DE2140089A	1400x890x24	1 pce	88
EchoCove® 24mm DESK TWO 590 L	EC024DE2160089A	1600x890x24	1 pce	101
EchoCove® 24mm DESK TWO 590 XL	EC024DE2180089A	1800x890x24	1 pce	113

**ECHOCOVE® 24MM
DESK TWO 470 XS**

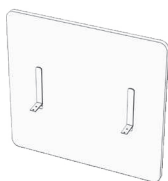

**ECHOCOVE® 24MM
DESK TWO 470 S**

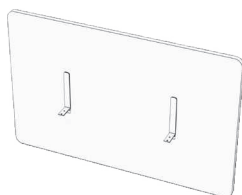

**ECHOCOVE® 24MM
DESK TWO 590 XS**

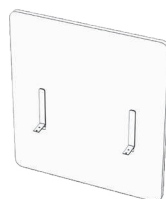

**ECHOCOVE® 24MM
DESK TWO 590 S**

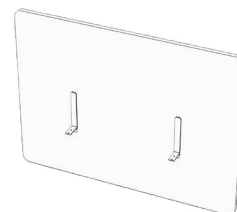

**ECHOCOVE® 24MM
DESK TWO 470 M**

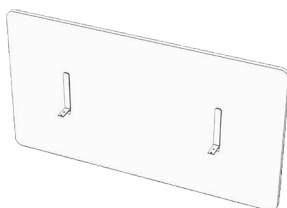

**ECHOCOVE® 24MM
DESK TWO 470 L**

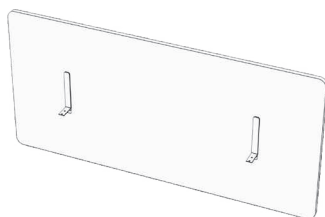

**ECHOCOVE® 24MM
DESK TWO 590 M**

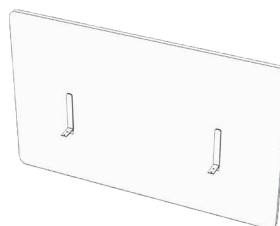

**ECHOCOVE® 24MM
DESK TWO 590 L**

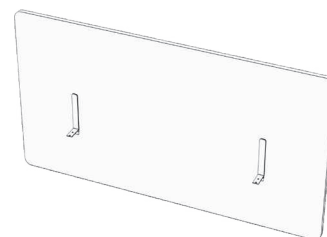

**ECHOCOVE® 24MM
DESK TWO 470 XL**

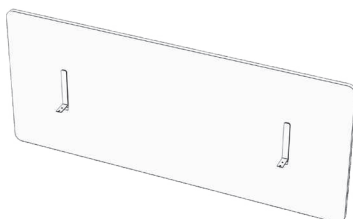

**ECHOCOVE® 24MM
DESK TWO 590 XL**

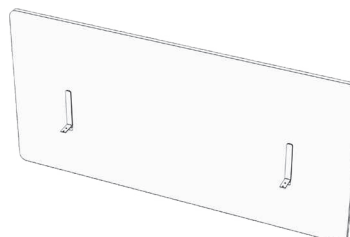





ACOUSTIC-FURNITURE

Design and function combined in one: acoustic furniture are utility and design elements made of EchoBoard® for improving the sound environment in rooms of all kinds.



ECHOCRATE®

EchoCrate® is the elegant acoustic solution for storage space in a small area. The EchoBoard® wall panel can be configured in any colour and shape and can be used in a wide variety of areas. The seemingly floating wall shelf is mounted on a powder-coated metal frame or a customised solution.

For the first time, the design combines two recycling concepts of beverage packaging, PET bottles and wine crates. Recycled PET was used to produce the decorative acoustic board and the practical shelves are made from upcycled wooden crates.



COMPANY PROFILE

MATERIAL

CEILING

LIGHTING

WALLS

PARTITIONS

FURNITURE

ADDITIONAL ITEMS

CREATE

ECHOCRATE® 24MM

Acoustic panels in various shapes and surface designs combined with storage made out of wooden crates incl. wall suspension.

Absorption coefficient: α_w 0.90, class A

Corner radius: 40mm

When ordering EchoCrate® RECTANGLE M & L items (ECR24REC079180- & ECR24REC120180-), please specify the type of suspension profile. ([Page 179](#))

NAME	ARTICLE	W x H x D (in mm)	UNIT	PET-BOTTLES
EchoCrate® 24mm HEXAGON LIGHT	ECR24HEX135118L	1350x1180x180mm	1 pce	91
EchoCrate® 24mm HEXAGON BALANCED	ECR24HEX135118B	1350x1180x180mm	1 pce	91
EchoCrate® 24mm HEXAGON COMPACT	ECR24HEX135118C	1350x1180x180mm	1 pce	91
EchoCrate® 24mm ROUND LIGHT	ECR24ROU125125L	1250x1250x180mm	1 pce	92
EchoCrate® 24mm ROUND BALANCED	ECR24ROU125125B	1250x1250x180mm	1 pce	92
EchoCrate® 24mm ROUND COMPACT	ECR24ROU125125C	1250x1250x180mm	1 pce	92
EchoCrate® 24mm SQUARE LIGHT	ECR24SQU120120L	1195x1195x180mm	1 pce	107
EchoCrate® 24mm SQUARE BALANCED	ECR24SQU120120B	1195x1195x180mm	1 pce	107
EchoCrate® 24mm SQUARE COMPACT	ECR24SQU120120C	1195x1195x180mm	1 pce	107
EchoCrate® 24mm RECTANGLE S LIGHT	ECR24REC079100L	790x1000x180mm	5 pce	296
EchoCrate® 24mm RECTANGLE S BALANCED	ECR24REC079100B	790x1000x180mm	5 pce	296
EchoCrate® 24mm RECTANGLE S COMPACT	ECR24REC079100C	790x1000x180mm	5 pce	296
EchoCrate® 24mm RECTANGLE M LIGHT	ECR24REC079180L	790x1800x180mm	1 pce	107
EchoCrate® 24mm RECTANGLE M BALANCED	ECR24REC079180B	790x1800x180mm	1 pce	107
EchoCrate® 24mm RECTANGLE M COMPACT	ECR24REC079180C	790x1800x180mm	1 pce	107
EchoCrate® 24mm RECTANGLE L LIGHT	ECR24REC120180L	1195x1800x180mm	1 pce	161
EchoCrate® 24mm RECTANGLE L BALANCED	ECR24REC120180B	1195x1800x180mm	1 pce	161
EchoCrate® 24mm RECTANGLE L COMPACT	ECR24REC120180C	1195x1800x180mm	1 pce	161

ECHOCRATE® 24MM
HEXAGON LIGHT

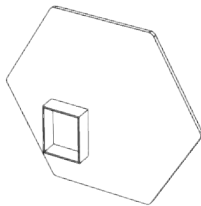

ECHOCRATE® 24MM
HEXAGON BALANCED

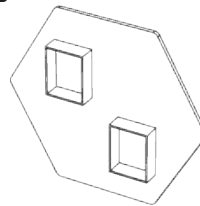

ECHOCRATE® 24MM
HEXAGON COMPACT

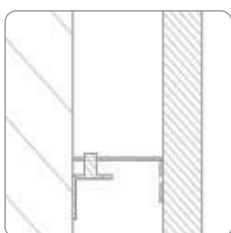
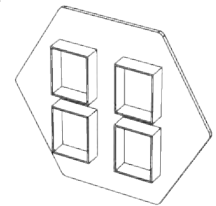

WALL SUSPENSION

**ECHO CRATE® 24MM
ROUND LIGHT**

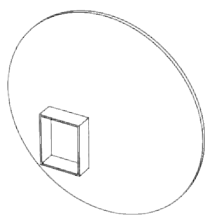

**ECHO CRATE® 24MM
ROUND BALANCED**

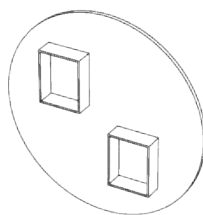

**ECHO CRATE® 24MM
ROUND COMPACT**

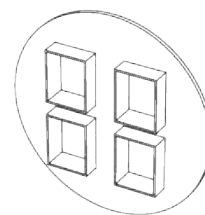

**ECHO CRATE® 24MM
SQUARE LIGHT**

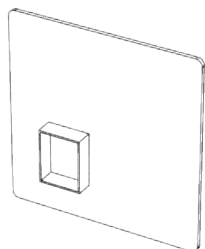

**ECHO CRATE® 24MM
SQUARE BALANCED**

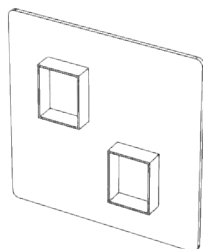

**ECHO CRATE® 24MM
SQUARE COMPACT**

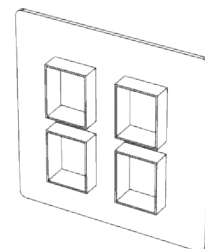

**ECHO CRATE® 24MM
RECTANGLE S LIGHT**

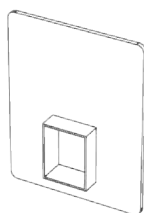

**ECHO CRATE® 24MM
RECTANGLE S BALANCED**

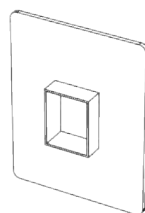

**ECHO CRATE® 24MM
RECTANGLE S COMPACT**

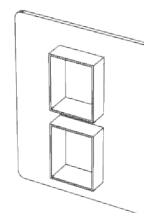

**ECHO CRATE® 24MM
RECTANGLE M LIGHT**

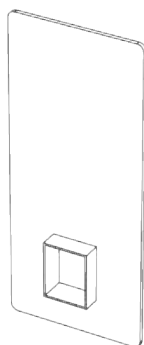

**ECHO CRATE® 24MM
RECTANGLE M BALANCED**

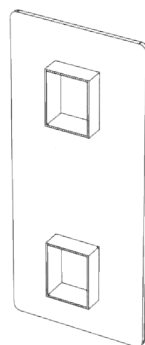

**ECHO CRATE® 24MM
RECTANGLE M COMPACT**

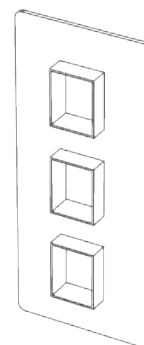

**ECHO CRATE® 24MM
RECTANGLE L LIGHT**

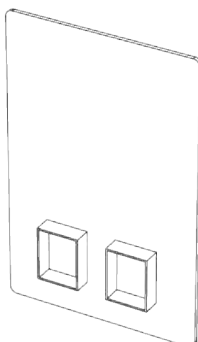

**ECHO CRATE® 24MM
RECTANGLE L BALANCED**

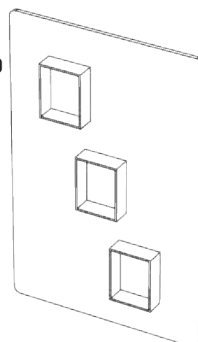

**ECHO CRATE® 24MM
RECTANGLE L COMPACT**

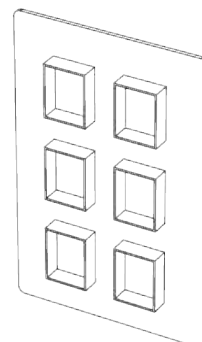

A large, dark blue, textured acoustic panel is mounted on a black metal frame with casters. The panel is positioned against a light-colored, textured concrete wall. The panel has a fine, woven texture and is rectangular in shape. The frame is minimalist and industrial in style.

ECHONOTE®

EchoNote® is a high-quality whiteboard with a pinboard on the back. It also serves as a functional, movable and sound-absorbing room divider. The magnetic board and the EchoBoard® acoustic panel are embedded in a minimalist frame made of powder-coated steel, the elegant feet are on castors.

EchoNote® cleverly adapts to the layout needs of offices, training rooms or meeting rooms. The large display area supports collaborative work

COMPANY PROFILE

MATERIAL

CEILING

LIGHTING

WALLS

PARTITIONS

FURNITURE

ADDITIONAL ITEMS

CREATE





Handwritten scribbles and faint markings on the concrete wall behind the whiteboard.



ECHONOTE® 12MM

High-performance acoustic whiteboard consisting of a pin board with textile surface made of 100% PET and a classic whiteboard surface. Optionally available with cover plates.

Absorption coefficient: [aw 0.30](#)

This product is optionally available with our magnetic cover plates. ([Page 181](#))



NAME	ARTICLE	W x H x D (in mm)	UNIT	PET-BOTTLES
EchoNote® 12mm	EN012STA119190A	1190x1900x430	1 pce	101

ECHONOTE® 12MM

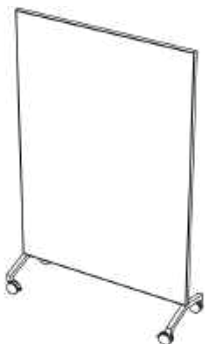

COMPANY PROFILE

MATERIAL

CEILING

LIGHTING

WALLS

PARTITIONS

FURNITURE

ADDITIONAL ITEMS

CREATE



ECHOTOWER® SQUARE

The EchoTower® is the pioneering product in zero noise and zero waste for any space. The acoustic column is cut from a sheet of EchoBoard®, the high-performance absorber made from recycled PET bottles. But that's not all. With a Zero Waste goal, ECHOJAZZ products are taken back and shredded into EchoFlakes® along with offcuts. Filled with these flakes, the EchoTower® increases acoustic well-being and closes the material cycle. The EchoTower® requires no assembly. A base, with or without castors, made of powder-coated sheet steel is optional.



COMPANY PROFILE

MATERIAL

CEILING

LIGHTING

WALLS

PARTITIONS

FURNITURE

ADDITIONAL ITEMS

CREATE



archiproducts
DESIGN AWARDS
—
WINNER 2020



ECHOTOWER® 24MM SQUARE

Free-standing acoustic column with optional adjustable base made of powder-coated steel (with or without castors).

Absorption coefficient: α_w 1.00, class A

More information about the product EchoTower® is available at www.echojazz.com/echotower-square



NAME	ARTICLE	W x H x D (in mm)	UNIT	PET-BOTTLES
EchoTower® SQUARE M ECO	ETW24SQE040098A	396x980x396	1 pce	399
EchoTower® SQUARE M STAND	ETW24SQS040098A	550x982x550	1 pce	399
EchoTower® SQUARE M MOVE	ETW24SQM040098A	550x1057x550	1 pce	399
EchoTower® SQUARE L ECO	ETW24SQE040196A	396x1960x396	1 pce	798
EchoTower® SQUARE L STAND	ETW24SQS040196A	550x1962x550	1 pce	798
EchoTower® SQUARE L MOVE	ETW24SQM040196A	550x2037x550	1 pce	798

**ECHOTOWER® 24MM
SQUARE M ECO**

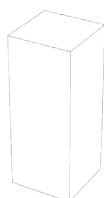

**ECHOTOWER® 24MM
SQUARE M STAND**

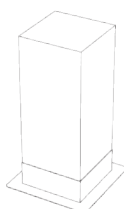

**ECHOTOWER® 24MM
SQUARE M MOVE**

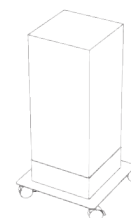

**ECHOTOWER® 24MM
SQUARE L ECO**



**ECHOTOWER® 24MM
SQUARE L STAND**



**ECHOTOWER® 24MM
SQUARE L MOVE**



archiproducts®

DESIGN AWARDS

—
WINNER 2020

COMPANY PROFILE

MATERIAL

CEILING

LIGHTING

WALLS

PARTITIONS

FURNITURE

ADDITIONAL ITEMS

CREATE



ECHOTOWER® ROUND

The EchoTower® is the leading product in zero noise and zero waste for every room. The acoustic column is cut from a single piece of EchoBoard®, the high-performance absorber made from recycled PET bottles. But that is not all, with a zero waste target, ECHO**JAZZ** products are taken back and shredded together with offcuts to produce EchoFlakes®. Filled with these flakes, the EchoTower® increases the acoustic comfort and closes the material cycle. The EchoTower® is freestanding. A stand base, with or without wheels, made of powder-coated steel is optional.

The acoustic column with relief structure is an eye-catcher that achieves outstanding absorption values and ensures well-being. The recyclable EchoTower® stands for sustainability by design without compromise - with more than 465 recycled PET bottles per tower.



COMPANY PROFILE

MATERIAL

CEILING

LIGHTING

WALLS

PARTITIONS

FURNITURE

ADDITIONAL ITEMS

CREATE



ECHOTOWER® 24MM ROUND

Free-standing acoustic filled with sound absorbing EchoFlakes®.

Absorption coefficient: α_w 1.00, class A

More information about the product EchoTower® is available at www.echojazz.com/echotower-round

NAME	ARTICLE	Ø x H (in mm)	UNIT	PET-BOTTLES
EchoTower® 24mm ROUND M WAVY ECO	ETW24R0E037093A	367x924	1 Pce	249
EchoTower® 24mm ROUND L WAVY ECO	ETW24R0E037180A	367x1800	1 Pce	465

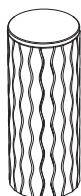

ECHOTOWER® 24MM
ROUND M WAVY ECO



ECHOTOWER® 24MM
ROUND L WAVY ECO



MCART

The **MCart** workstation offers the combination of personal focus space with mobile adaptability. Its compact dimensions make it suitable for working in an open office as well as a home office. The starting point for the design is an open steel frame. **ECHOJAZZ** panels define a semi-enclosed workspace with optimal sound insulation, simple body and colour accent. The acoustics in the overall space are also significantly improved. A gas lift column allows the height of the worktop to be adjusted from 70 to 112 cm in a matter of seconds. From standing to sitting and vice versa in real time.



COMPANY PROFILE

MATERIAL

CEILING

LIGHTING

WALLS

PARTITIONS

FURNITURE

ADDITIONAL ITEMS

CREATE

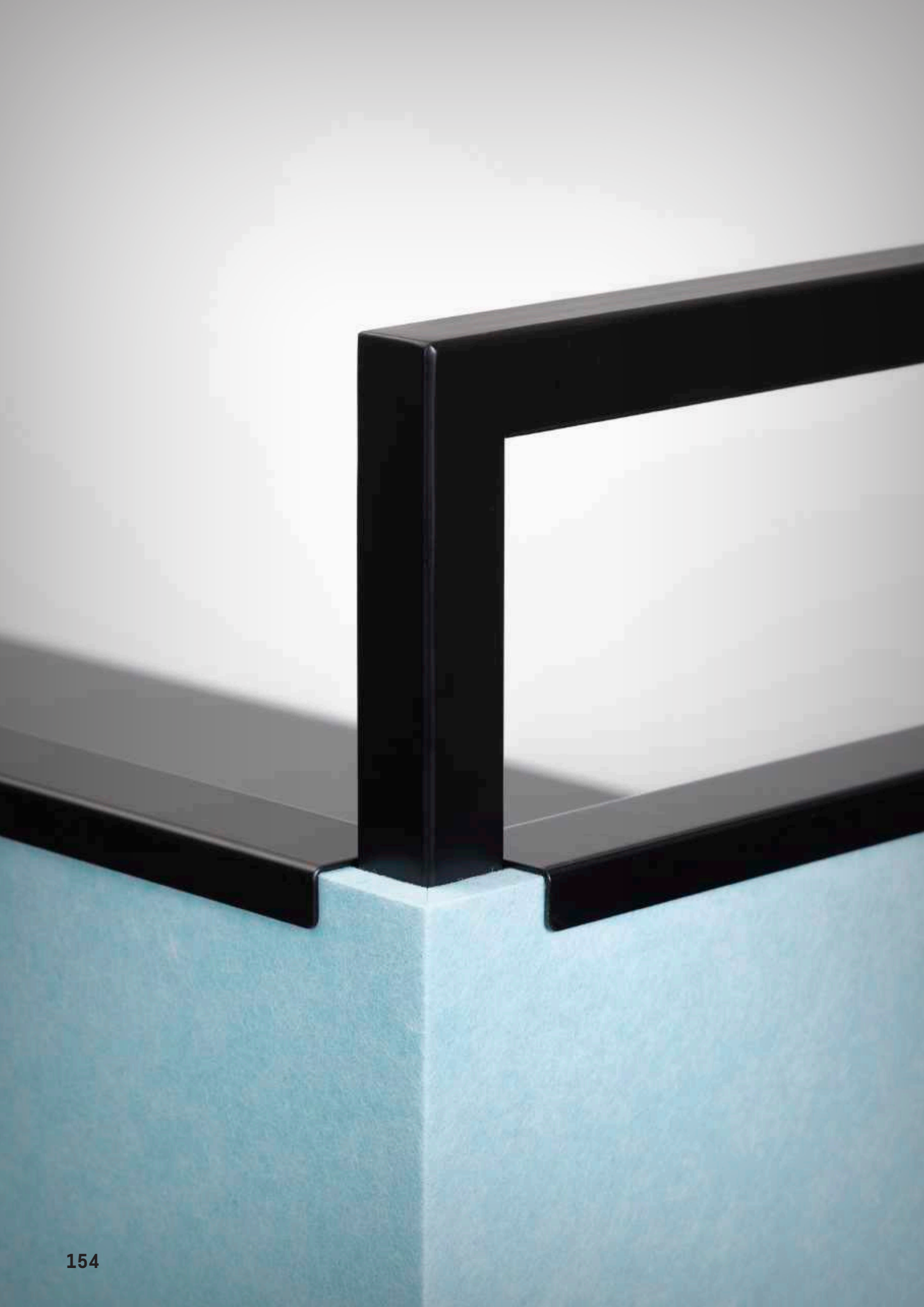

MCART 12MM

Mobile acoustic workstation on wheels with integrated plug-in bar and hydraulically height-adjustable table top.

Absorption coefficient: α_w 0.90, class A

Please chose the right MCart ELECTRICAL SOCKET type (CH/EU/UK) when ordering. (Page 177)

More information about the product MCart is available at www.echojazz.com/mcart



NAME	ARTICLE	W x H x D (in mm)	UNIT	PET-BOTTLES
MCart 12mm ZERO	MCA12ST0120615	1228x1473x613	1 pce	145
MCart 12mm ONE	MCA12ST1150615	1456x1473x613	1 pce	189
MCart 12mm TWO	MCA12ST2170615	1681x1473x613	1 pce	232

**MCART 12MM
ZERO**



**MCART 12MM
ONE**



**MCART 12MM
TWO**

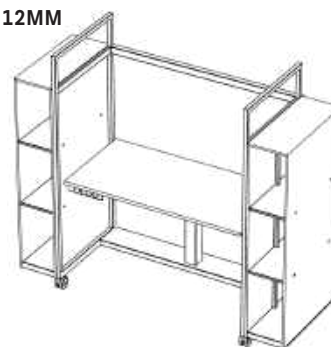



ECHOCARRY

The EchoCarry is an office organiser for personal equipment. At the workplace, laptop, accessories, office materials and private things are always well tidied and easily at hand thanks to two storage positions. The integrated handle allows the toolbox to be quickly stored in a compartment or cupboard at the end of the working day.

The elegant office companion is made of the acoustic absorber EchoBoard® around a stable wooden board made of European birch. In use, it is very quiet and muffles ambient noise. The EchoCarry symbolises the focus on ergonomics in the modern mobile working environment.

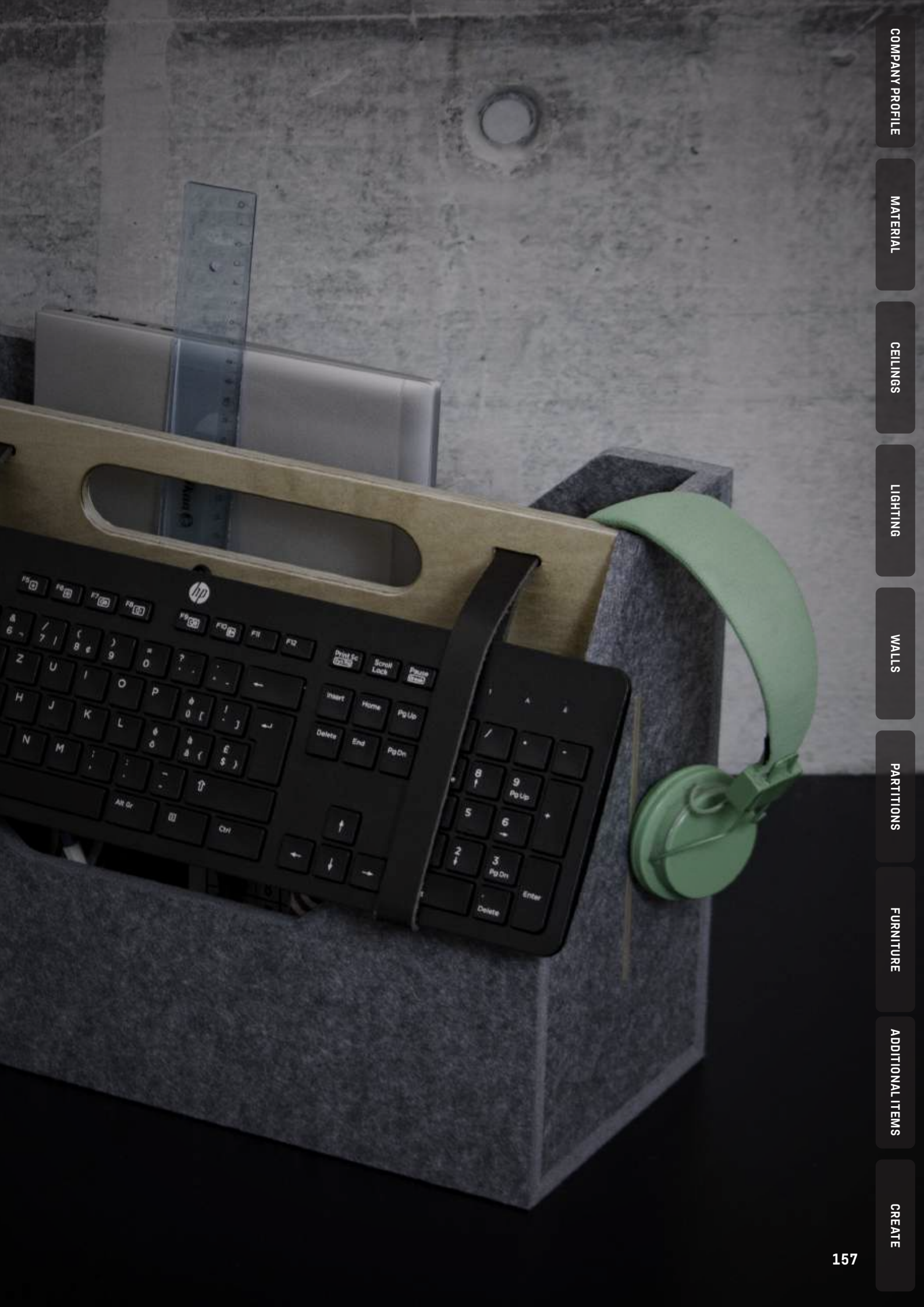

COMPANY PROFILE

MATERIAL

CEILING

LIGHTING

WALLS

PARTITIONS

FURNITURE

ADDITIONAL ITEMS

CREATE



ECHOCARRY 12MM

Mobile acoustic office-organiser with integrated handle and optional leather straps.

Absorption coefficient: α_w 0.90, class A

When ordering, please indicate whether you wish to receive the EchoCarry with the optional leather straps

You can find more information about the EchoCarry at www.echojazz.com/echocarry



NAME	ARTICLE	W x H x D (in mm)	UNIT	PET-BOTTLES
EchoCarry 12mm	ECA12040031019A	400x312x190	1 pce	18
EchoCarry 12mm LEATHER STRAPS	ECA12ELS012002A	210x19x3	2 pce	

ECHOCARRY 12MM

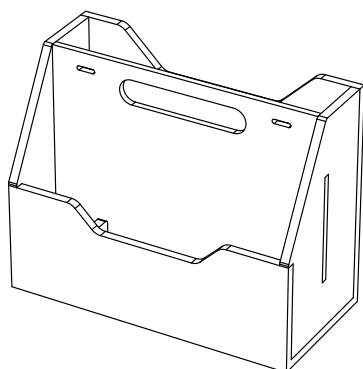

ECHOCARRY 12MM
+ LEATHER STRAPS

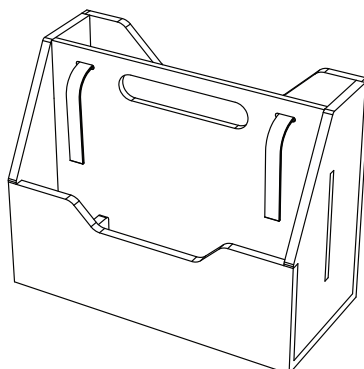



ECHOBX®

In the Open Office, telephone calls and video calls at the workplace can be disturbing. The sound-protected EchoBox® ensures privacy and less disruptive noise. A room within a room for short and focused conversations, while standing or sitting. Thanks to the integrated height-adjustable shelf, there is also room for documents or a laptop. The conversation booth can be assembled in no time without tools. Its 7 parts weigh only 42kg.

The EchoBox® is a Swiss product that resulted from an intensive development cooperation between SYMA Profile and Fastening Technology and ECHO **JAZZ** Acoustic Absorbers.

We build Acoustic Inspiration.



COMPANY PROFILE

MATERIAL

CEILING

LIGHTING

WALLS

PARTITIONS

FURNITURE

ADDITIONAL ITEMS

CREATE



ECHOBOX® 24MM

Stand-alone quiet booth with height-adjustable table and fold-away chair.

Absorption coefficient: α_w 1.00, class A

Tool-free assembly

More information about the product EchoBox® is available at www.echojazz.com/echobox



NAME	ARTICLE	W x H x D (in mm)	UNIT	PET-BOTTLES
EchoBox® 24mm SILVER FRAME	EB024SIL084220A	840x2200x840	1 pce	582
EchoBox® 24mm WHITE FRAME	EB024WEI084220A	840x2200x840	1 pce	582
EchoBox® 24mm BLACK FRAME	EB024BLA084220A	840x2200x840	1 pce	582
EchoBox® 24mm SILVER FRAME (+ GLASS DOOR)	EB024SGD084220A	840x2200x840	1 Pce	582
EchoBox® 24mm WHITE FRAME (+ GLASS DOOR)	EB024WGD084220A	840x2200x840	1 Pce	582
EchoBox® 24mm BLACK FRAME (+ GLASS DOOR)	EB024BGD084220A	840x2200x840	1 Pce	582

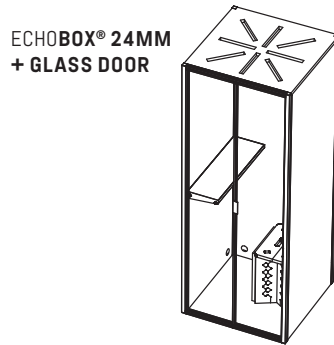
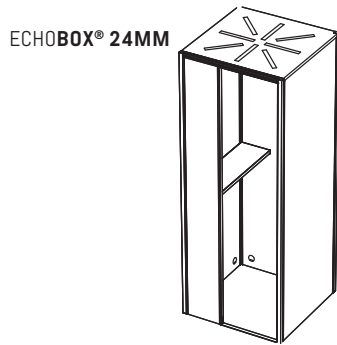





COMPANY PROFILE

MATERIAL

CEILING

LIGHTING

WALLS

PARTITIONS

FURNITURE

ADDITIONAL ITEMS

CREATE

ADDITIONAL ITEMS

The installation should be from a single source and perfectly matched to the acoustic product. That is why **ECHOJAZZ** has developed its own installation kits and accessories that can be ordered as well. For optimal and seamless project support.



ECHOCOUSTIC® 25MM PROFILE

EchoCoustic® can optionally be installed with EchoProfile® aluminium profiles. With EchoCoustic® 25mm PROFILE profiles, installation is also possible without adhesive. An EchoCoustic® panel can be easily clamped between two profiles.

This article is part of the product EchoCoustic®. ([Page 26](#))

NAME	ARTICLE	W x H x D (in mm)	UNIT	MATERIAL
EchoCoustic® 25mm PROFILE EDGE	EPR25EDG000000A	2750x16x27.8	1 pce	Aluminium
EchoCoustic® 25mm PROFILE SPLIT	EPR25SPL000000A	2750x30.6x27.8	1 pce	Aluminium

ECHOCOUSTIC® 25MM
PROFILE EDGE

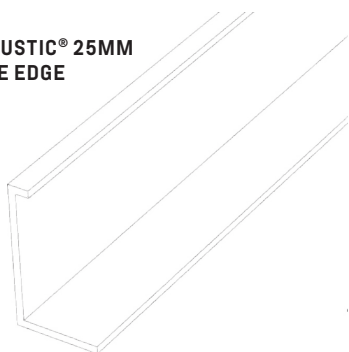

ECHOCOUSTIC® 25MM
PROFILE SPLIT

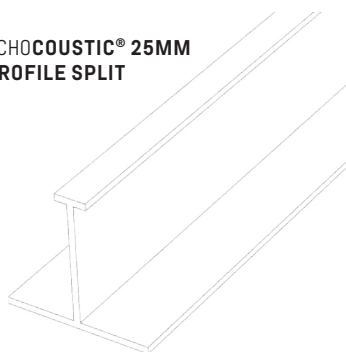



ECHOBaffle® CUSTOM DESIGN

DESIGN: RIPPLE EFFECT

SLAT DISTANCE: 200mm

SUSPENSION SYSTEM: U-PROFILE

SLAT CONNECTIONS: DOVETAIL JOINTS

ECHOBaffle® CUSTOM DESIGN OPTIONS

EchoBaffle® ceilings are flexible in their application. The slats are available with closed edges or with dovetail connections. To hang the EchoBaffle®, there is the option of a direct suspension system or u-profiles.

This article is part of the product EchoBaffle®. (Page 46)

OPTIONS	DESCRIPTION
Design	PLAIN; CORNER; VOGUE; CUSTOM DESIGN
Slat distance	Distance between slats
Suspension system	Direct suspension; U-profile
Slat connections	Closed edge; Dovetail joint

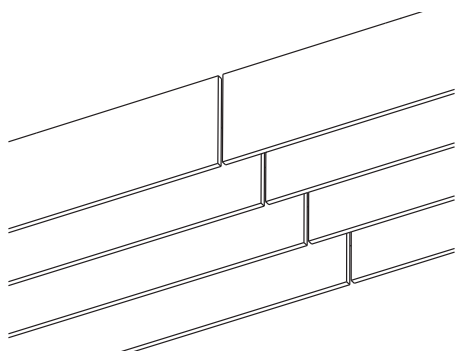

CLOSED EDGE

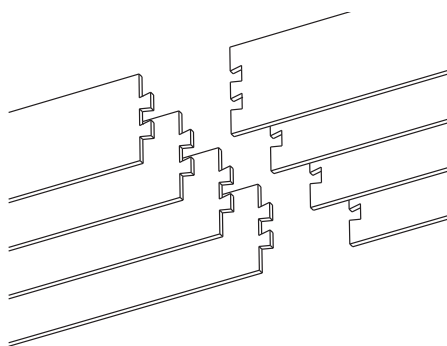

DOVETAIL JOINT

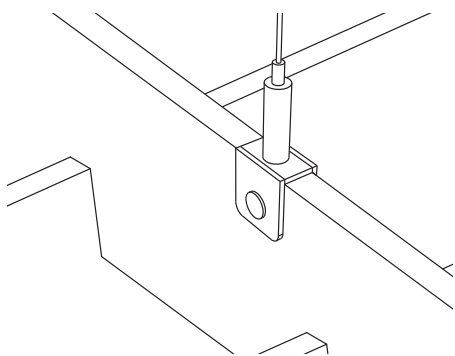

DIRECT SUSPENSION

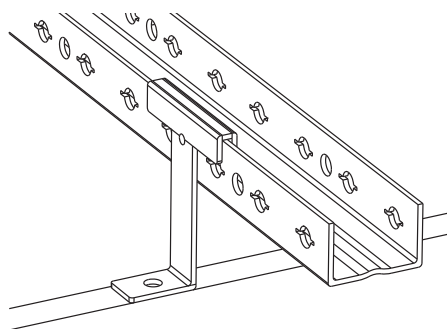

U-PROFILE SUSPENSION

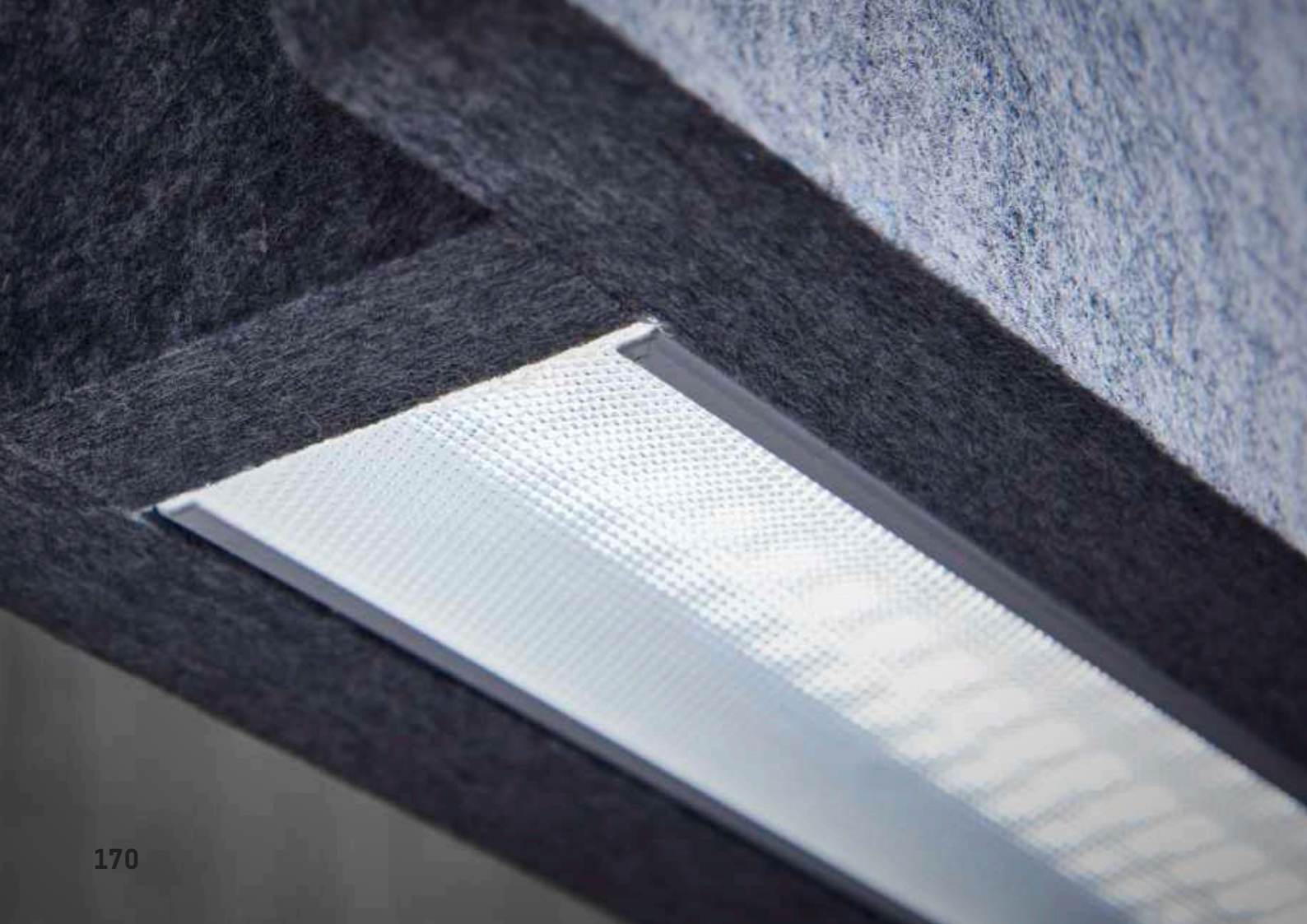

ECHOLED® EQ4 PIN BY BARTENBACH

The EchoLED® EQ4 PIN with four light points was developed in cooperation with Bartenbach, the competence partner for light sources.

[This article is part of the product EchoLED® EQ4. \(Page 56\)](#)

[This article is part of the product EchoLED® UMBRA. \(Page 64\)](#)

TYP	ARTICLE	W x H x D (in mm)	LIGHT COLOURS	LUMEN	PERFORMANCE
EQ4 3000	ELI00EQ3000000A	486x73.9x50 (4 x Ø30)	3000K	1320lm	22W
EQ4 4000	ELI00EQ4000000A	486x73.9x50 (4 x Ø30)	4000k	1320lm	22W

SUPPLY VOLTAGE	220-240V 50/60Hz
PROTECTION TYPE/-CLASS	IP 40 / Schutzklasse 1
COLOUR RENDERING INDEX	CRI > 90 (4000K)
COLOUR CONSISTENCY	< 3SDMC
ENERGIEEFFIZIENZ	A++
LIFETIME	> 50'000 h (L80 B10)
UGR	< 16

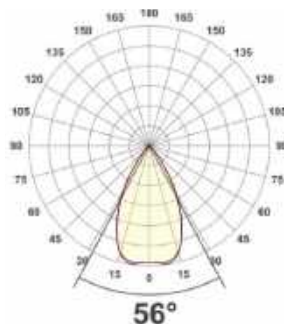

Bartenbach [®]

ECHOLED® LINEAR LED

The EchoLED® LINEAR LED light module with different light colours and dimensions.

[This article is part of the product EchoLED® LINEAR. \(Page 68\)](#)

TYP	ARTICLE	W x H x D (in mm)	LIGHT COLOUR	LUMEN	PERFORMANCE
M 3000	ELI0030K142000A	1420x69x90	3000K	4200lm	33W
L 3000	ELI0030K198000A	1980x69x90	3000K	5400lm	41W
M 4000	ELI0040K142000A	1420x69x90	4000K	4700lm	33W
L 4000	ELI0040K198000A	1980x69x90	4000K	6100lm	41W

SUPPLY VOLTAGE	230 V +/- 10% AC/DC
PROTECTION TYPE/-CLASS	IP 20 / Schutzklasse 1
COLOUR RENDERING INDEX	CRI > 80
COLOUR CONSISTENCY	< 3SDMC
ENERGIEEFFIZIENZ	A++
LIFETIME	> 50'000 h (L80 B10)
DIFFUSOR	Microprism cover
UGR	< 19

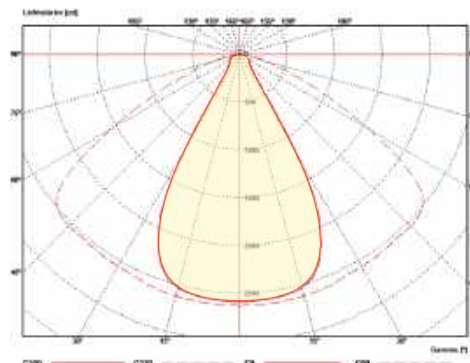

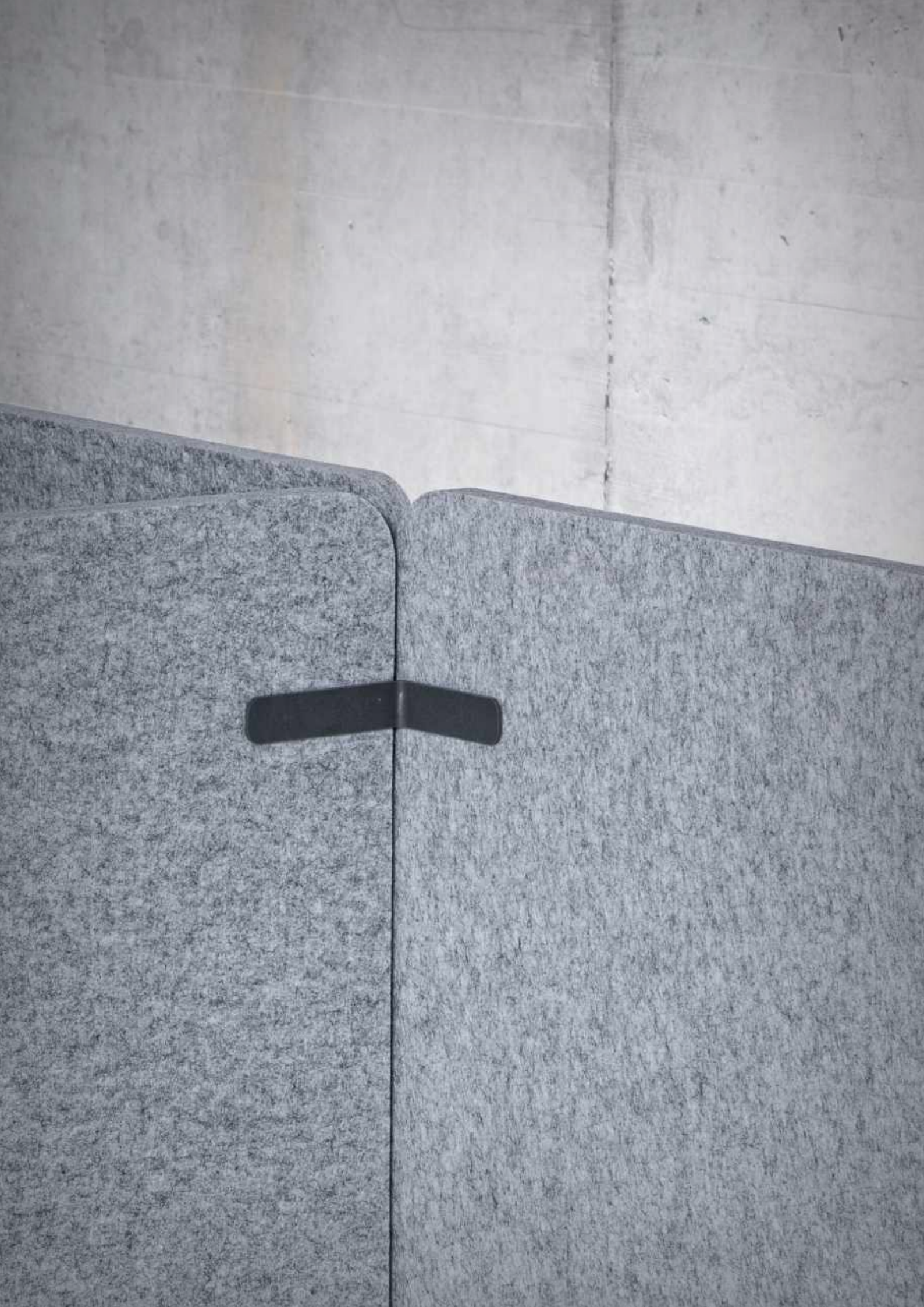

ECHOCOVE® JOINER

Plastic plug-in connector for mounting EchoCove® ECO and EchoCove® PALING partitions without tools.

This item is only available with the products EchoCove® ECO & PALING. [\(Page 110\)](#)

NAME	ARTICLE	W x H x D (in mm)	UNIT	MATERIAL
EchoCove® JOINER 90	EJ000090100000A	129x30x129	1 pce	ABS
EchoCove® JOINER 120	EJ000120100000A	112x30x129	1 pce	ABS
EchoCove® JOINER PIVOT	EJ000PIV300000A	28x25x209	1 pce	ABS
EchoCove® JOINER STRAIGHT	EJ000STR200000A	29x30x129	1 pce	ABS
EchoCove® JOINER T	EJ000TJO100000A	197x30x129	1 pce	ABS
EchoCove® JOINER X	EJ000XJO100000A	229x30x229	1 pce	ABS

ECHOCOVE® JOINER
120

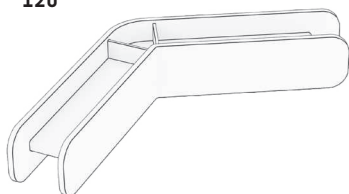

ECHOCOVE® JOINER
90

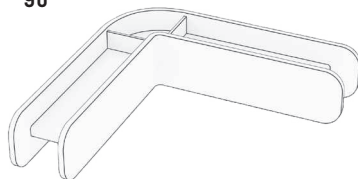

ECHOCOVE® JOINER
PIVOT

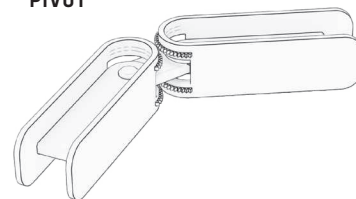

ECHOCOVE® JOINER
STRAIGHT

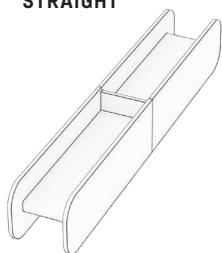

ECHOCOVE® JOINER
T

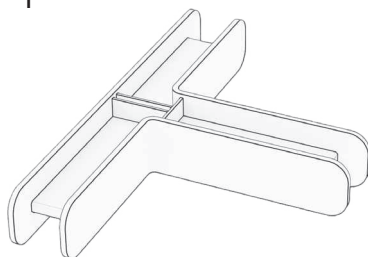

ECHOCOVE® JOINER
X

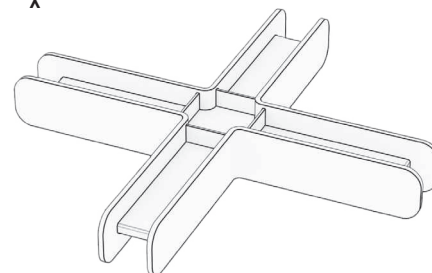



ECHOCOVE® DESK ADAPTER

Powder coated metal adapter for mounting EchoCove® 24mm DESK ONE and DESK TWO desk dividers.

Colour adapter: [Black RAL9005](#)

From an order quantity of 20 sets, the desk adapters are available in all RAL colours at a surcharge of 5%.

This item is only available with the product EchoCove® DESK. ([Page 128](#))

NAME	ARTICLE	W x H x D (in mm)	UNIT	MATERIAL
EchoCove® DESK ADAPTER A	EAD00ECA000000A	25x200x102 (Direct mounting)	1 pce	Powder coated steel
EchoCove® DESK ADAPTER B	EAD00ECB000000A	25x218x68 (Clamping range up to 30mm)	1 pce	Powder coated steel
EchoCove® DESK ADAPTER C	EAD00ECC000000A	25x262x68 (Clamping range 46-75mm)	1 pce	Powder coated steel

ECHOCOVE®
ADAPTER A

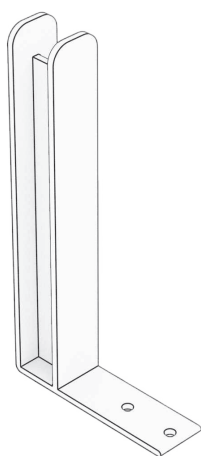

ECHOCOVE®
ADAPTER B

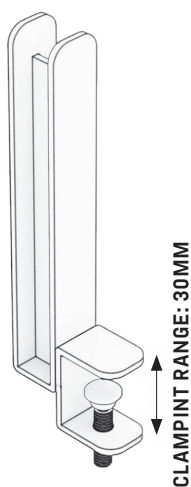

ECHOCOVE®
ADAPTER C

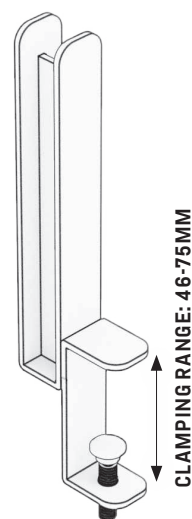



MCART ELECTRICAL SOCKET

Powder coated metal adapter for mounting EchoCove® 24mm DESK ONE and DESK TWO desk dividers.

Colour adapter: [Black RAL9005](#)

This article is part of the product MCart. ([Page 152](#))

NAME	ARTICLE	W x H x D (in mm)	UNIT	MATERIAL
CH	MCA12ELS00CH00A	215x37x50	1 pce	Stahl pulverbeschichtet
EU	MCA12ELS00EU00A	215x37x50	1 pce	Stahl pulverbeschichtet
UK	MCA12ELS00UK00A	215x37x50	1 pce	Stahl pulverbeschichtet

MCART ELECTRICAL SOCKET
CH

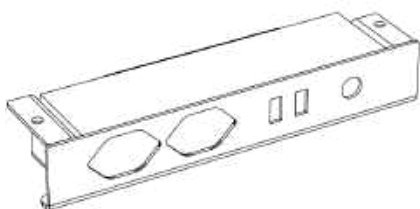

MCART ELECTRICAL SOCKET
EU



MCART ELECTRICAL SOCKET
UK

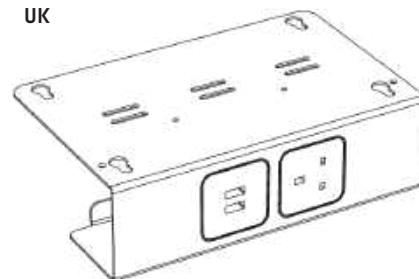



ECHOCRATE® SUSPENSION PROFILE

Depending on how the EchoCrate® RECTANGLE M & L products are hung, a different suspension profile is required. Please specify the correct suspension profile when ordering.

This article relates to the products EchoCrate® RECTANGLE M & L. (Page 138)

NAME	ARTICLE	W x H x D (in mm)	UNIT	MATERIAL
Horizontal Orientation	EPR00APR001050A	1050x50x20	1 pce	Steel powdercoated
Vertical Orientation	EPR00APR000550A	550x50x20	1 pce	Steel powdercoated

**SUSPENSION PROFILE
HORIZONTAL ORIENTATION**



**SUSPENSION PROFILE
VERTICAL ORIENTATION**





ECHONOTE® 12MM COVER

Pinable cover plate, which can be easily attached to and removed from the whiteboard thanks to magnets on the back.

[This article is part of the product EchoNote®. \(Page 143\)](#)

NAME	ARTICLE	W x H x D (in mm)	UNIT	MATERIAL
EchoNote® 12mm COVER	EN012COV086060A	595x855x12	2 pce	EchoBoard® 12mm

ECHONOTE® 12MM COVER

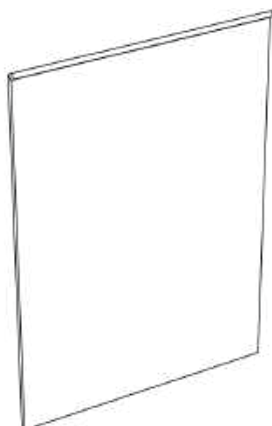

Our material can be very well customised. The large selection of colours is just the beginning. The surface can be cut, perforated or even printed on. Are you inspired by the EchoBoard® or another of our products? Don't hesitate to ask and maybe our design department already has a solution ready.





COMPANY PROFILE

MATERIAL

CEILING

LIGHTING

WALLS

PARTITIONS

FURNITURE

ADDITIONAL ITEMS

CREATE

CREATE



COLOURS

Let yourself be inspired by our colourful selection of colours. The fibres dyed in a liquid state do not fade and are very colourfast. For larger projects, we will even be happy to create your personal colour shade.

COLOURS

Due to the nature of the material, surface and colour deviations are possible.

You can always find the latest colour moods online at www.echojazz.com/colours



801
SUNFLOWER



592
PUMPKIN



852
CHILI



784
BUBBLEGUM



675
AUBERGINE



563
DEEP



372
SANTORINI



155
AQUA



523
MALDIVES



833
AVENTURINE



133
FOREST



245
ASPHALT



105
SNOW



111
MOUSE



244
KOALA



809
BEACH



204
MOCCA



185
CROCODILE



183
LIME



263
KERMIT



975
OLIVE

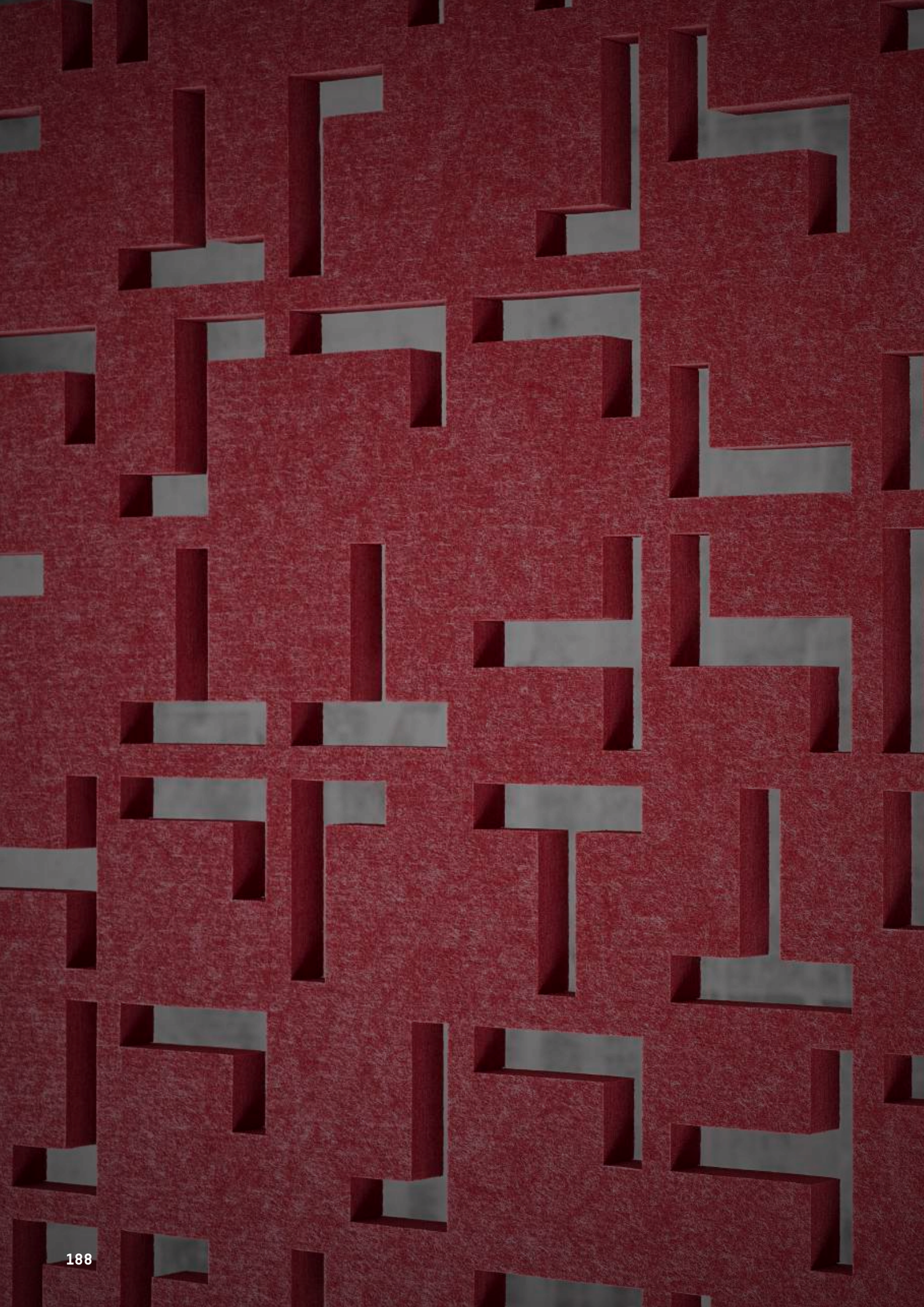



COMPANY PROFILE

MATERIAL

CEILING

LIGHTING

WALLS

PARTITIONS

FURNITURE

ADDITIONAL ITEMS

CREATE

PERFORATIONS

All products are cut to order at ECHO**JAZZ**. The possibilities for perforation are as individual as the sizes and shapes. In addition to your own pattern ideas or company logos, we also offer a current collection designed by our designers.

PERFORATIONS

Perforations as an additional option for various ECHOJAZZ products.

Special dimensions and designs on request

You can always find the latest designs online at www.echojazz.com/perforations

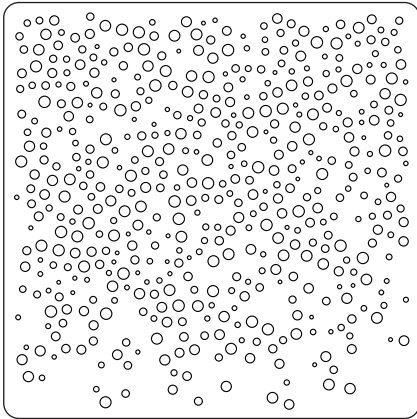

SPARKLY - K

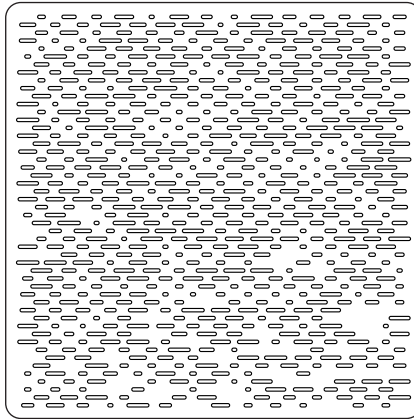

PEN - L

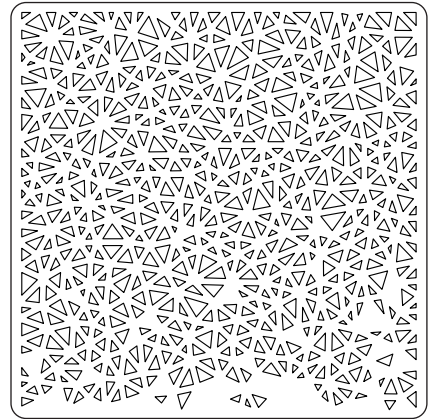

MESH - M

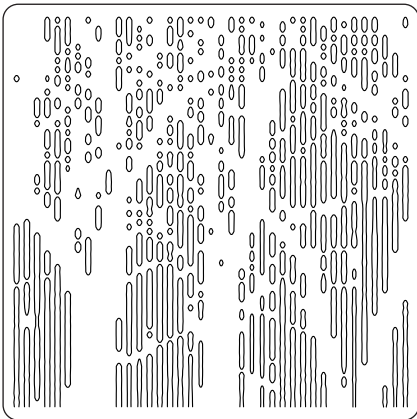

JUNGLE - N

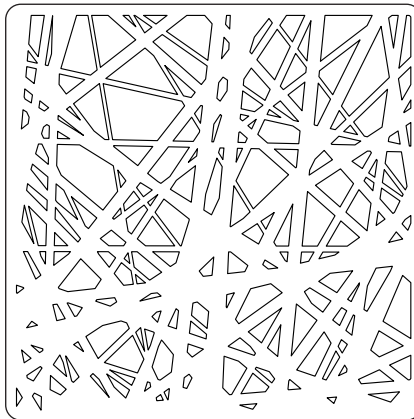

BEAM - O

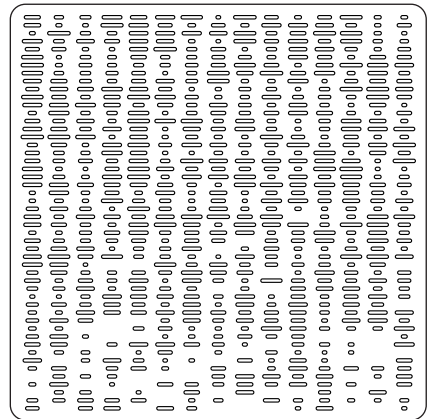

ZEN - P

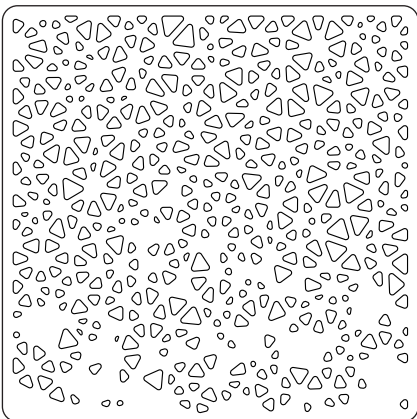

PETALS - Q

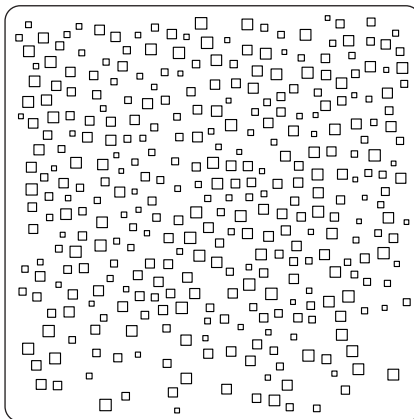

CITY - R

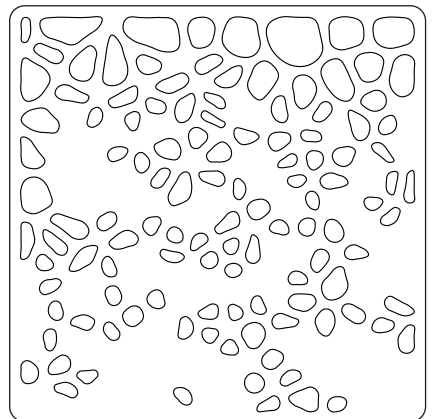

GECKO - S

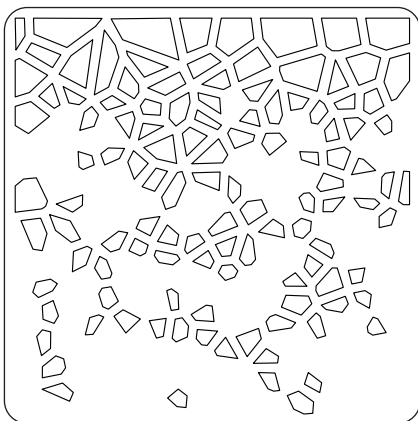

SPIDER - T

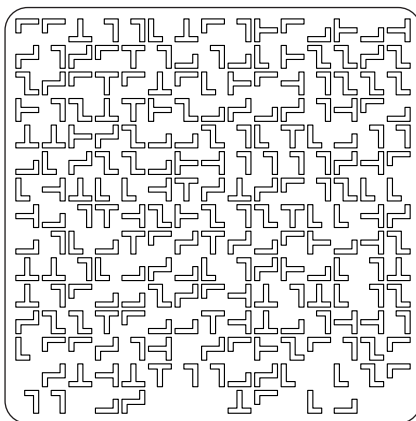

BLOCKS - U

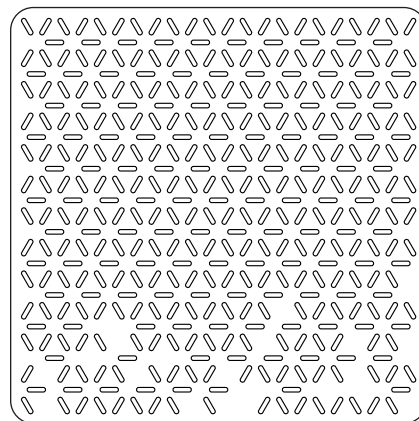

BASILIKA - V

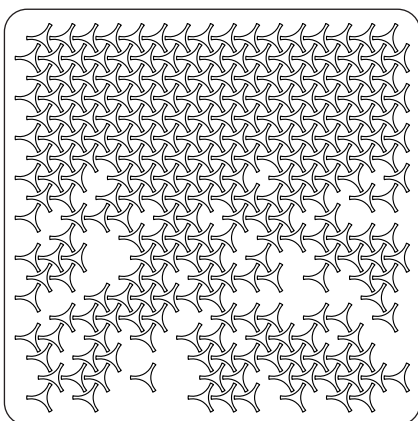

CELTIC - W

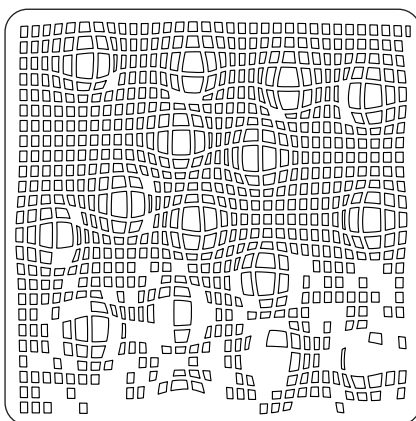

PULL - X

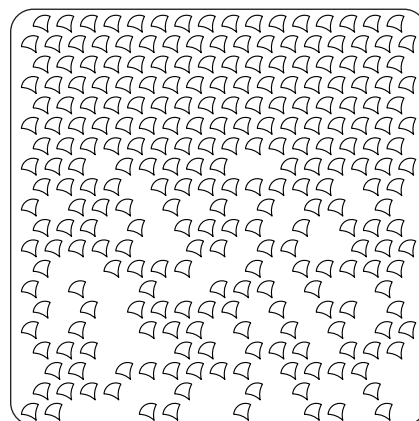

ARC - Y

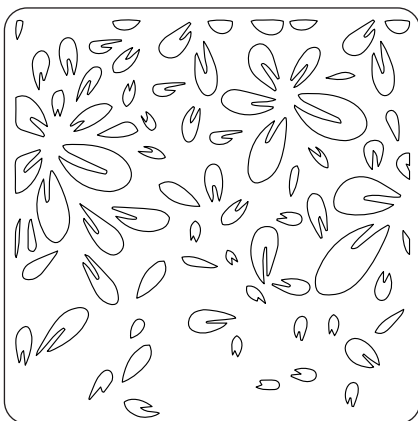

FLOWERS - Z

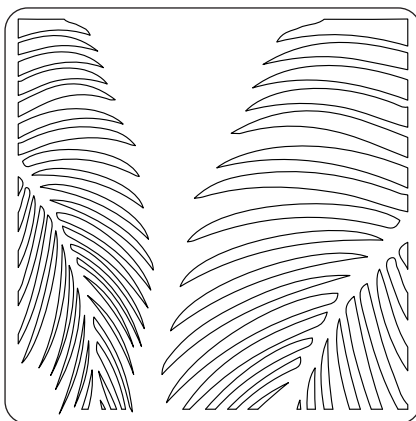

PALM - AB

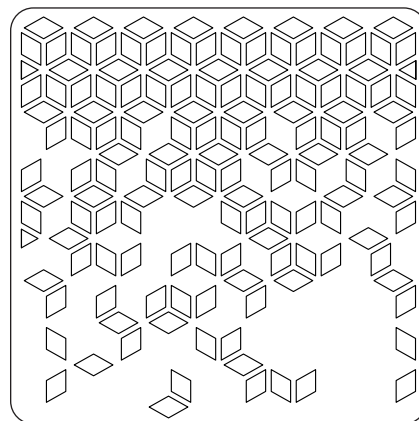

CUBE - AC



ECHOJAZZ

INSPIRED BY ACOUSTICS AND SUSTAINABILITY

100% PET ACOUSTIC ABSORBERS

EN-20230512